

Deckeneinbaustrahler PRO

74158-50 DA – 8.9W CCT Einbaustrahler SET IP44 Blattfeder Variante

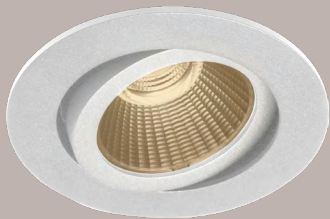

 Tunable White 



DALI DT8 dimmbar mit
Feller Power-Drehgeber TW
40085.DALI

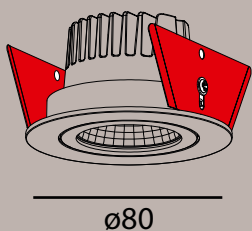

New 74158-50-36-00 DA

1800–4000K



1011lm



weiss matt

Abstrahlwinkel

36°

New 74158-50-60-00 DA

1800–4000K



1011lm



weiss matt

60°



Spannung	220-240V AC, 50Hz (inkl. 500mA Konverter / dimmbar)		
Schutzart	IP 44		
Schutzklasse:	III		
LED	bridgelux	V8 Gen 7	
Leistung	8.9W		
Farbwiedergabe Ra	90		
Optik	Reflektor, Schutzglas klar		
Schwenkbar	20°		
Material Gehäuse	Aluminium		
Einbau	Blattfedern		
Ausschnitt / Einbautiefe	AS ø68mm / ET 60mm		
Massangaben Strahler	ø80 × 45mm		
Konverter	120 × 52 × 23mm		

Feller Drehdimmer



88

88

Schutzart	IP20
Stromversorgung	230 V
DALI Steuerstrom	56mA
FürDALI Protokoll	DT6 / DT8 Tc
Eingabeoptionen	Drehen / Drücken / Halten / 2 × Drücken
Speicher	Minimale Helligkeit / Einschaltelligkeit
Abmessungen	88 × 88 × 34mm

Anzahl von DALI Geräten	Broadcast	DALI Adressen	DALI Gruppen	Dim	CCT	RGBW
27		—	—			—

FE 548502000

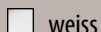

weiss

DALI Drehdimmer DT8 Tc

FE 548010950

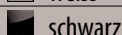

schwarz

DALI Drehdimmer DT8 Tc

74158 – 8.9W Einbaustrahler SET IP44

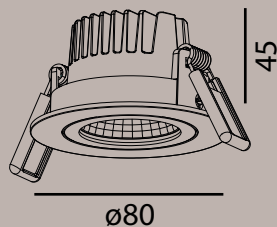
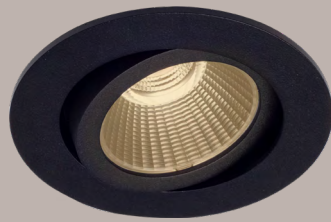

Phasenabschnitt dimmbar mit
Feller LED Universaldimmer
40200.LED



Spannung	220-240V AC, 50Hz (inkl. 500mA Konverter / dimmbar)
Schutzart	IP 44
Schutzklasse:	III
LED	bridgelux. V8 Gen 7
Leistung	8.9W
Farbwiedergabe Ra	90
Optik	Reflektor, Schutzglas klar
Schwenkbar	20°
Material Gehäuse	Aluminium
Einbau	Spreizfedern
Ausschnitt / Einbautiefe	AS ø68mm / ET 60mm
Massangaben Strahler	ø80 × 45mm
Konverter	115 × 40 × 22mm

						Abstrahlwinkel
74158-27-36-00-ST	2700K	A G	E	1011lm	weiss matt	36°
74158-27-36-02-ST	2700K	A G	E	1011lm	schwarz matt	36°
74158-30-36-00-ST	3000K	A G	E	1051lm	weiss matt	36°
74158-30-36-02-ST	3000K	A G	E	1051lm	schwarz matt	36°
74158-27-60-00-ST	2700K	A G	E	1011lm	weiss matt	60°
74158-27-60-02-ST	2700K	A G	E	1011lm	schwarz matt	60°
74158-30-60-00-ST	3000K	A G	E	1051lm	weiss matt	60°
74158-30-60-02-ST	3000K	A G	E	1051lm	schwarz matt	60°

74158-DA – 8.9W Einbaustrahler SET IP44

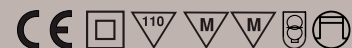
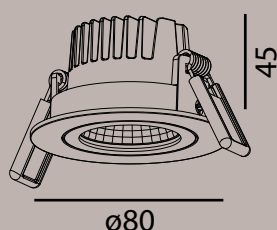
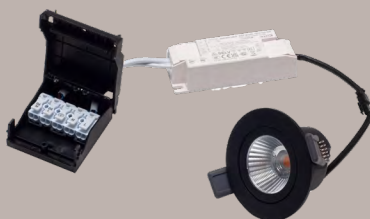
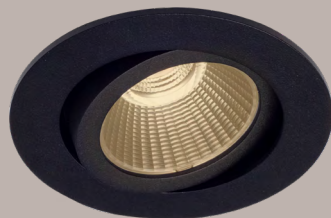

Spannung	220-240V AC, 50Hz (inkl. 500mA Konverter / dimmbar)
Schutzart	IP 44
Schutzklasse:	III
LED	bridgelux. V8 Gen 7
Leistung	8.9W
Farbwiedergabe Ra	90
Optik	Reflektor, Schutzglas klar
Schwenkbar	20°
Material Gehäuse	Aluminium
Einbau	Spreizfedern
Ausschnitt / Einbautiefe	AS ø68mm / ET 60mm
Massangaben Strahler	ø80 × 45mm
Konverter	111 × 36 × 25mm

						Abstrahlwinkel
74158-27-36-00 DA	2700K	A G	E	1011lm	weiss matt	36°
74158-27-36-02 DA	2700K	A G	E	1011lm	schwarz matt	36°
74158-30-36-00 DA	3000K	A G	E	1051lm	weiss matt	36°
74158-30-36-02 DA	3000K	A G	E	1051lm	schwarz matt	36°
74158-27-60-00 DA	2700K	A G	E	1011lm	weiss matt	60°
74158-27-60-02 DA	2700K	A G	E	1011lm	schwarz matt	60°
74158-30-60-00 DA	3000K	A G	E	1051lm	weiss matt	60°
74158-30-60-02 DA	3000K	A G	E	1051lm	schwarz matt	60°



74150 – 6.1W 35mm Einbaustrahler IP44

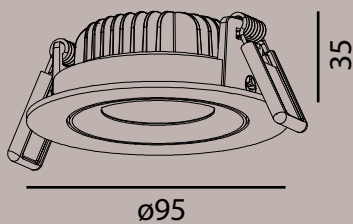
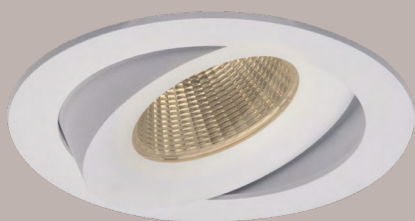

ø95



Strom DC	350mA
	(Bitte passenden Konverter dazu bestellen)
Schutzart	IP 44
Schutzklasse:	III
LED	bridgelux. V8 Gen 7
Leistung	6.1W
Farbwiedergabe Ra	90
Optik	Reflektor, Schutzglas klar
Schwenkbar	20°
Material Gehäuse	Aluminium
Einbau	Spreizfedern
Ausschnitt / Einbautiefe	AS ø80mm / ET 50mm
Massangaben	ø95 × 35mm

74150-27-00

2700K



727lm



weiss matt

Abstrahlwinkel

36°

74150-30-00

3000K



757lm



weiss matt

36°

Zubehör

74150-RF15 15° Reflektor

74150-RF24 24° Reflektor

74150-RF60 60° Reflektor

205080 Einbaugehäuse mit Tank AS ø80mm

74150 – 6.1W 35mm Einbaustrahler SET IP44

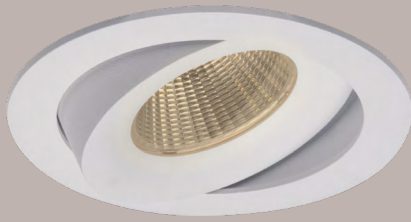

Phasenabschnitt dimmbar mit
Feller LED Universaldimmer
40200.LED

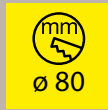
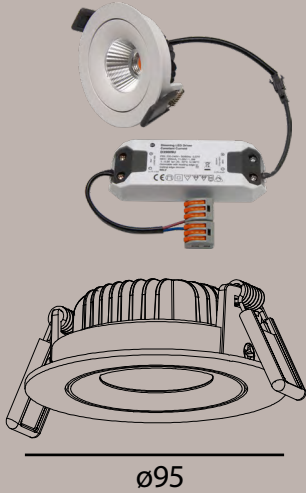

Spannung	220-240V AC, 50Hz (inkl. 350mA Konverter / dimmbar)
Schutzart	IP 44
Schutzklasse:	III
LED	bridgelux V8 Gen 7
Leistung	6.1W
Farbwiedergabe Ra	90
Optik	Reflektor, Schutzglas klar
Schwenkbar	20°
Material Gehäuse	Aluminium
Einbau	Spreizfedern
Ausschnitt / Einbautiefe	AS ø80mm / ET 50mm
Massangaben Strahler	ø95 × 35mm
Konverter	115 × 40 × 22mm

Modell	Temperatur	Effizienz	Fluss	Farbe	Abstrahlwinkel
74150-27-00-SET	2700K	E	727lm	weiss matt	36°
74150-27-02-SET	2700K	E	727lm	schwarz matt	36°
74150-27-05-SET	2700K	E	727lm	nickel satin	36°
74150-30-00-SET	3000K	D	757lm	weiss matt	36°
74150-30-02-SET	3000K	D	757lm	schwarz matt	36°
74150-30-05-SET	3000K	D	757lm	nickel satin	36°

74150-DA – 6.1W 35mm Einbaustrahler SET IP44

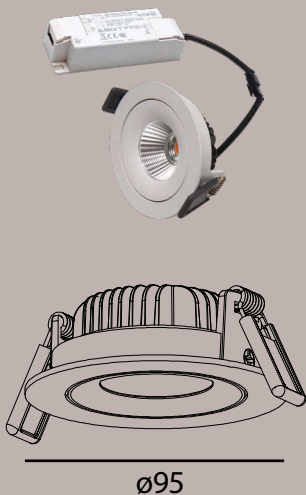
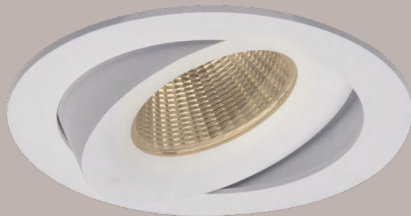

Spannung	220-240V AC, 50Hz (inkl. 350mA Konverter / dimmbar)
Schutzart	IP 44
Schutzklasse:	III
LED	bridgelux V8 Gen 7
Leistung	6.1W
Farbwiedergabe Ra	90
Optik	Reflektor, Schutzglas klar
Schwenkbar	20°
Material Gehäuse	Aluminium
Einbau	Spreizfedern
Ausschnitt / Einbautiefe	AS ø80mm / ET 50mm
Massangaben Strahler	ø95 × 35mm
Konverter	111 × 36 × 25mm

Modell	Temperatur	Effizienz	Fluss	Farbe	Abstrahlwinkel
74150-27-00 DA	2700K	E	727lm	weiss matt	36°
74150-27-02 DA	2700K	E	727lm	schwarz matt	36°
74150-27-05 DA	2700K	E	727lm	nickel satin	36°
74150-30-00 DA	3000K	D	757lm	weiss matt	36°
74150-30-02 DA	3000K	D	757lm	schwarz matt	36°
74150-30-05 DA	3000K	D	757lm	nickel satin	36°



74155 / 74156 – 8.9W 50mm Einbaustrahler IP44

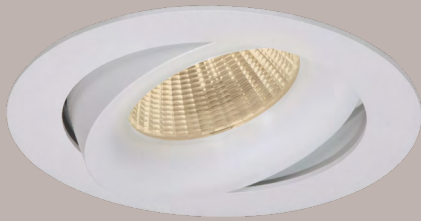

Strom DC **500mA**
(Bitte passenden Konverter dazu bestellen)

Schutzart IP 44

Schutzklasse: III

LED **bridgelux** V8 Gen 7

Leistung 8.9W

Farbwiedergabe Ra 90

Optik Reflektor, Schutzglas klar

Schwenkbar 20°

Material Gehäuse Aluminium

Einbau Spreizfedern

Ausschnitt / Einbautiefe AS ø80mm / ET 70mm

Massangaben ø95 × 50mm

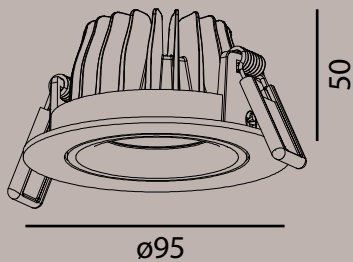

ø95

50

Abstrahlwinkel

74155-27-00	2700K		1011lm		weiss matt	36°
74155-27-02	2700K		1011lm		schwarz	36°
74155-30-00	3000K		1051lm		weiss matt	36°
74155-30-02	3000K		1051lm		schwarz	36°
74155-40-00	4000K		1126lm		weiss matt	36°
74156-27-00	2700K		1011lm		weiss matt	60°
74156-27-02	2700K		1011lm		schwarz	60°
74156-30-00	3000K		1051lm		weiss matt	60°
74156-30-02	3000K		1051lm		schwarz	60°
74156-40-00	4000K		1126lm		weiss matt	60°

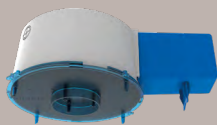

Zubehör

74150-RF15 15° Reflektor für **Lens** Anbaustrahler

74150-RF24 24° Reflektor für **Lens** Anbaustrahler

205080 Einbaugehäuse mit Tank AS ø80mm

74155 / 74156 – 8.9W 50mm Einbaustrahler SET IP44

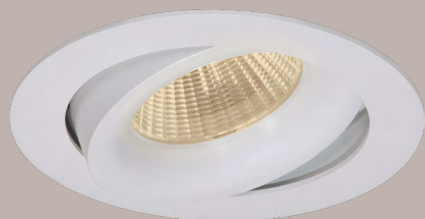

Phasenabschnitt dimmbar mit
Feller LED Universaldimmer
40200.LED

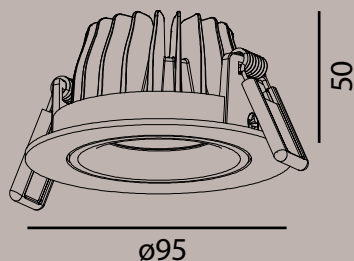

Spannung	220-240V AC, 50Hz (inkl. 500mA Konverter / dimmbar)
Schutzart	IP 44
Schutzklasse:	III
LED	bridgelux V8 Gen 7
Leistung	8.9W
Farbwiedergabe Ra	90
Optik	Reflektor, Schutzglas klar
Schwenkbar	20°
Material Gehäuse	Aluminium
Einbau	Spreizfedern
Ausschnitt / Einbautiefe	AS ø80mm / ET 70mm
Massangaben Strahler	ø95 × 50mm
Konverter	115 × 40 × 22mm

Modell	Temperatur	Effizienz	Fluss	Farbe	Abstrahlwinkel
74155-27-00-SET	2700K	A+ E	1011lm	weiss matt	36°
74155-27-02-SET	2700K	A+ E	1011lm	schwarz matt	36°
74155-30-00-SET	3000K	A+ E	1051lm	weiss matt	36°
74155-30-02-SET	3000K	A+ E	1051lm	schwarz matt	36°
74156-27-00-SET	2700K	A+ E	1011lm	weiss matt	60°
74156-27-02-SET	2700K	A+ E	1011lm	schwarz matt	60°
74156-30-00-SET	3000K	A+ E	1051lm	weiss matt	60°
74156-30-02-SET	3000K	A+ E	1051lm	schwarz matt	60°

74155-DA / 74156-DA – 8.9W 50mm Einbaustrahler DALI SET IP44

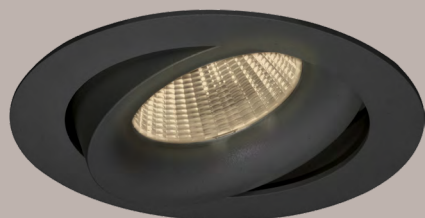

Phasenabschnitt dimmbar mit
Feller LED Universaldimmer
40200.LED

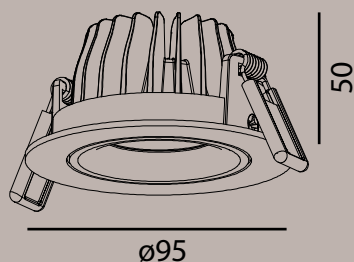

Spannung	220-240V AC, 50Hz (inkl. 500mA Konverter / dimmbar)
Schutzart	IP 44
Schutzklasse:	III
LED	bridgelux V8 Gen 7
Leistung	8.9W
Farbwiedergabe Ra	90
Optik	Reflektor, Schutzglas klar
Schwenkbar	20°
Material Gehäuse	Aluminium
Einbau	Spreizfedern
Ausschnitt / Einbautiefe	AS ø80mm / ET 70mm
Massangaben Strahler	ø95 × 50mm
Konverter	111 × 36 × 25mm

Modell	Temperatur	Effizienz	Fluss	Farbe	Abstrahlwinkel
74155-27-00 DA	2700K	A+ E	1011lm	weiss matt	36°
74155-27-02 DA	2700K	A+ E	1011lm	schwarz matt	36°
74155-30-00 DA	3000K	A+ E	1051lm	weiss matt	36°
74155-30-02 DA	3000K	A+ E	1051lm	schwarz matt	36°
74156-27-00 DA	2700K	A+ E	1011lm	weiss matt	60°
74156-27-02 DA	2700K	A+ E	1011lm	schwarz matt	60°
74156-30-00 DA	3000K	A+ E	1051lm	weiss matt	60°
74156-30-02 DA	3000K	A+ E	1051lm	schwarz matt	60°

74155 / 74156 BF – 8.9W 50mm Einbaustrahler SET IP44 Blattfeder Variante

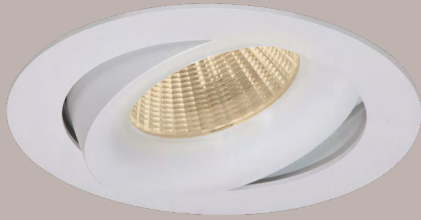

Phasenabschnitt dimmbar mit
Feller LED Universaldimmer
40200.LED

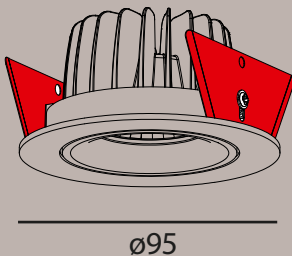

						Abstrahlwinkel
New	74155-27-00 BF ST	2700K		1011lm	<input type="checkbox"/> weiss matt	36°
New	74155-30-00 BF ST	3000K		1051lm	<input type="checkbox"/> weiss matt	36°
New	74156-27-00 BF ST	2700K		1011lm	<input type="checkbox"/> weiss matt	60°
New	74156-30-00 BF ST	3000K		1051lm	<input type="checkbox"/> weiss matt	60°



Spannung	220-240V AC, 50Hz (inkl. 500mA Konverter / dimmbar)
Schutzart	IP 44
Schutzklasse:	III
LED	bridgelux. V8 Gen 7
Leistung	8.9W
Farbwiedergabe Ra	90
Optik	Reflektor, Schutzglas klar
Schwenkbar	20°
Material Gehäuse	Aluminium
Einbau	Blattfedern
Ausschnitt / Einbautiefe	AS ø80mm / ET 70mm
Massangaben Strahler	ø95 × 50mm
Konverter	115 × 40 × 22mm

74155 / 74156 BF DA – 8.9W 50mm Einbaustrahler SET IP44 Blattfeder Variante

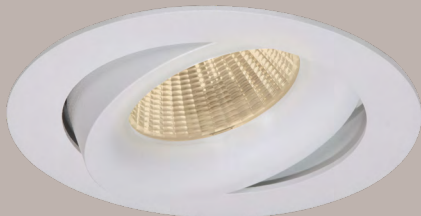

Phasenabschnitt dimmbar mit
Feller LED Universaldimmer
40200.LED

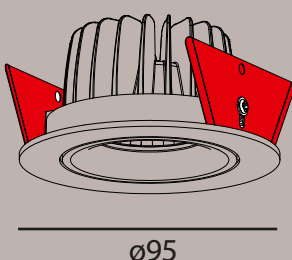

						Abstrahlwinkel
New	74155-27-00 BF DA	2700K		1011lm	<input type="checkbox"/> weiss matt	36°
New	74155-30-00 BF DA	3000K		1051lm	<input type="checkbox"/> weiss matt	36°
New	74156-27-00 BF DA	2700K		1011lm	<input type="checkbox"/> weiss matt	60°
New	74156-30-00 BF DA	3000K		1051lm	<input type="checkbox"/> weiss matt	60°

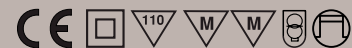

Spannung	220-240V AC, 50Hz (inkl. 500mA Konverter / dimmbar)
Schutzart	IP 44
Schutzklasse:	III
LED	bridgelux. V8 Gen 7
Leistung	8.9W
Farbwiedergabe Ra	90
Optik	Reflektor, Schutzglas klar
Schwenkbar	20°
Material Gehäuse	Aluminium
Einbau	Blattfedern
Ausschnitt / Einbautiefe	AS ø80mm / ET 70mm
Massangaben Strahler	ø95 × 50mm
Konverter	111 × 36 × 25mm



Tunable White



Betriebsart DALI DT8

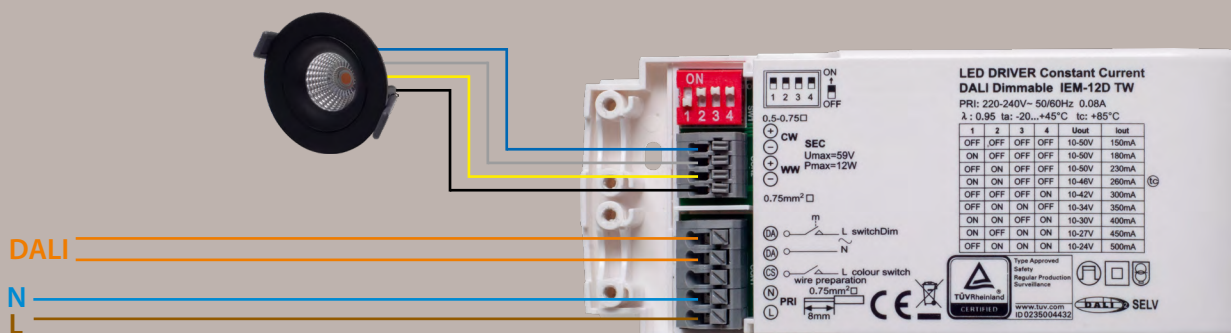

Feller Drehdimmer

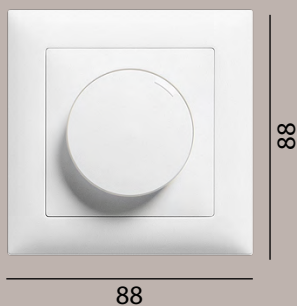

Schutzart	IP20
Stromversorgung	230 V
DALI Steuerstrom	56mA
FürDALI Protokoll	DT6 / DT8 Tc
Eingabeoptionen	Drehen / Drücken / Halten / 2 × Drücken
Speicher	Minimale Helligkeit / Einschaltelligkeit
Abmessungen	88 × 88 × 34mm

Anzahl von DALI Geräten	Broadcast	DALI Adressen	DALI Gruppen	Dim	CCT	RGBW
27	✓	—	—	✓	✓	—

FE 548502000

 weiss

DALI Drehdimmer DT8 Tc

FE 548010950

 schwarz

DALI Drehdimmer DT8 Tc

74155-50 / 74156-50 DA – 8.9W CCT Einbaustrahler SET IP44

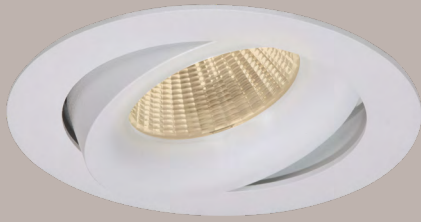

Tunable White

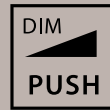

DALI DT8 dimmbar mit Feller Power-Drehgeber TW 40085.DALI

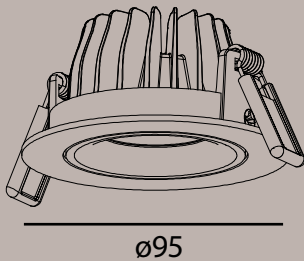

						Abstrahlwinkel
New	74155-50-00 DA	1800-4000K		1011lm	<input type="checkbox"/> weiss matt	36°
New	74155-50-02 DA	1800-4000K		1011lm	<input checked="" type="checkbox"/> schwarz matt	36°
New	74156-50-00 DA	1800-4000K		1011lm	<input type="checkbox"/> weiss matt	60°
New	74156-50-02 DA	1800-4000K		1011lm	<input checked="" type="checkbox"/> schwarz matt	60°



Spannung	220-240V AC, 50Hz (inkl. 500mA Konverter / dimmbar)	
Schutzart	IP 44	
Schutzklasse:	III	
LED	bridgelux.	V8 Gen 7
Leistung	8.9W	
Farbwiedergabe Ra	90	
Optik	Reflektor, Schutzglas klar	
Schwenkbar	20°	
Material Gehäuse	Aluminium	
Einbau	Spreizfedern	
Ausschnitt / Einbautiefe	AS Ø80mm / ET 70mm	
Massangaben Strahler	Ø95 × 50mm	
Konverter	120 × 52 × 23mm	

74155-50 / 74156-50 DA – 8.9W CCT Einbaustrahler SET IP44 Blattfeder Variante

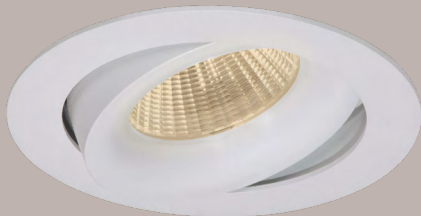

Tunable White



DALI DT8 dimmbar mit Feller Power-Drehgeber TW 40085.DALI

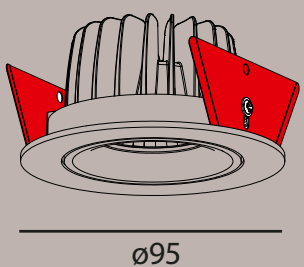

New	74155-50-00 BF DA	1800-4000K		1011lm	<input type="checkbox"/> weiss matt	36°
New	74156-50-00 BF DA	1800-4000K		1011lm	<input type="checkbox"/> weiss matt	60°



Spannung	220-240V AC, 50Hz (inkl. 500mA Konverter / dimmbar)	
Schutzart	IP 44	
Schutzklasse:	III	
LED	bridgelux.	V8 Gen 7
Leistung	8.9W	
Farbwiedergabe Ra	90	
Optik	Reflektor, Schutzglas klar	
Schwenkbar	20°	
Material Gehäuse	Aluminium	
Einbau	Blattfedern	
Ausschnitt / Einbautiefe	AS Ø80mm / ET 70mm	
Massangaben Strahler	Ø95 × 50mm	
Konverter	120 × 52 × 23mm	

74176 – 8.9W Einbaustrahler kardanisch Sets IP44

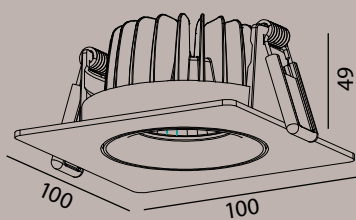
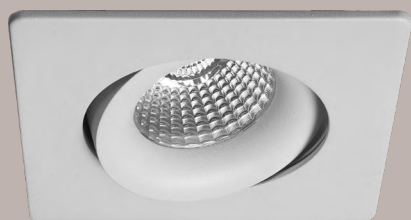

Strom DC	500mA
Schutzart	IP 44
Schutzklasse:	III
LED	bridgelux V8 Gen 7
Leistung	8.9W
Farbwiedergabe Ra	90
Optik	Reflektor, Schutzglas klar
Dreh- und schwenkbar	40° / 360°
Material Gehäuse	Aluminium
Einbau	Spreizfedern
Ausschnitt / Einbautiefe	AS ø85mm / ET 70mm
Massangaben	100 × 100 × 49mm



						Abstrahlwinkel
New	74176-27-00 SET	2700K	A G E	1011lm	weiss matt	60°
New	74176-30-00 SET	3000K	A G E	1051lm	weiss matt	60°



						Abstrahlwinkel
New	74176-27-00 DA	2700K	A G E	1011lm	weiss matt	60°
New	74176-27-02 DA	2700K	A G E	1011lm	schwarz	60°
New	74176-30-00 DA	3000K	A G E	1051lm	weiss matt	60°
New	74176-30-02 DA	3000K	A G E	1051lm	schwarz	60°



						Abstrahlwinkel
New	74176-50-00 DA	1800–4000K	A G E	1011lm	weiss matt	60°
New	74176-50-02 DA	1800–4000K	A G E	1011lm	schwarz matt	60°

74276 – 2 × 8.9W Einbaustrahler kardanisich Sets IP44



Strom DC	500mA
	(Bitte passenden Konverter dazu bestellen)
Schutzart	IP 44
Schutzklasse:	III
LED	bridgelux V8 Gen 7
Leistung	2 × 8.9W
Farbwiedergabe Ra	90
Optik	Reflektor, Schutzglas klar
Dreh- und schwenkbar	40° / 360°
Material Gehäuse	Aluminium
Einbau	Spreizfedern
Ausschnitt / Einbautiefe	AS 85 × 170mm / ET 70mm
Massangaben	100 × 100 × 49mm

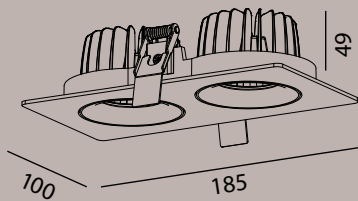

New	74276-27-00 ST	2700K			2 × 1011lm	<input type="checkbox"/> weiss matt	Abstrahlwinkel 60°
New	74276-30-00 ST	3000K			2 × 1051lm	<input type="checkbox"/> weiss matt	60°

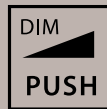

New	74276-27-00 DA	2700K			2 × 1011lm	<input type="checkbox"/> weiss matt	Abstrahlwinkel 60°
New	74276-27-02 DA	2700K			2 × 1011lm	<input checked="" type="checkbox"/> schwarz	60°
New	74276-30-00 DA	3000K			2 × 1051lm	<input type="checkbox"/> weiss matt	60°
New	74276-30-02 DA	3000K			2 × 1051lm	<input checked="" type="checkbox"/> schwarz	60°

Tunable White



New	74276-50-00 DA	1800–4000K			2 × 1011lm	<input type="checkbox"/> weiss matt	Abstrahlwinkel 60°
New	74276-50-02 DA	1800–4000K			2 × 1011lm	<input checked="" type="checkbox"/> schwarz matt	60°

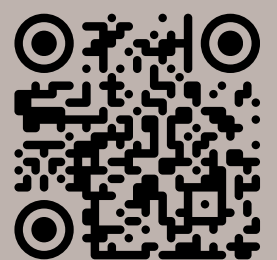

www.lichtconcept.ch