



Index



Einbaustrahler & LED Module

4



Deckeneinbauleuchten

14



Möbeleinbauleuchten

50

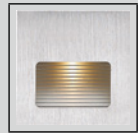

Wandeinbauleuchten

54



Halbeinbauleuchten

60



Anbauleuchten 230V

74



Pendelleuchten 230V

102



Schienenstrahler

116



Konverter & Zubehör

150

Einbaustrahler & LED Module





7 5638



8 740040/41

6.2W LED



9 740042/43

9.2W LED



10 740044/45

12.4W LED



11 740044/45

13W Dim to Warm



13 740018

GU10 Retrofit



5638 Einbaustrahler / 5638 - SET



Für Leuchtmittel Bauform	PAR16 und LED Retrofit ø50mm (bitte dazu bestellen)
Fassung	GU10 Fassung separat bestellen
Schutzart	IP 20
Schutzklasse	III
Material Gehäuse	Aluminium Druckguss
Schwenkbar	30°
Einbau	Blattfedern
Ausschnitt / Einbautiefe	AS ø80mm / ET 130
Massangaben	ø95mm

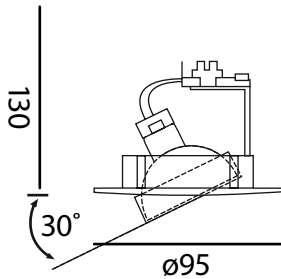

- 5638-00 weiss matt
- 5638-01 weiss
- 5638-02 schwarz matt
- 5638-05 nickel satin
- 5638-09 chrommatt

Zubehör

- 56001 GU10 Fassung **ohne** Klemmbügel sonderisoliert
- 56003 GU10 Fassung **mit** Klemmbügel sonderisoliert

<input type="checkbox"/> weiss matt	<input type="checkbox"/> nickel satin
<input type="checkbox"/> weiss <input type="checkbox"/> schwarz matt	<input type="checkbox"/> chrommatt

GU10 SET		Set beinhaltet: 1× Einbaustrahler 5638 1× GU10 Leuchtmittel (dimmbar) 1× GU10 Fassung		38°	2700K 3000K	5W		
LED Modul DIM SET		Set beinhaltet: 1× Einbaustrahler 5638 1× LED Modul (6W/9W/12.4W) 1× Konverter (dimmbar)		40° / 60°	2700K 3000K 4000K	6W 9W		
		Set beinhaltet: 1× Einbaustrahler 5638 1× DTW LED Modul (13W) 1× Konverter (dimmbar)		40° / 60°	1800-3000K	13W		
LED Modul DALI SET		Set beinhaltet: 1× Einbaustrahler 5638 1× LED Modul (6W/9W) 1× Konverter (DALI DT6)		40° / 60°	2700K 3000K 4000K	6W 9W		
		Set beinhaltet: 1× Einbaustrahler 5638 1× DTW LED Modul (13W) 1× Konverter (DALI DT6)		40° / 60°	1800-3000K	13W		

6.2W SET Retrofit LED Modul & Konverter



Spannung	220-240V AC, 50Hz (inkl. 350mA Konverter / dimmbar)
Schutzart	IP 20
Schutzklasse:	II

LED	bridgelux. V8
Leistung	6.2W
Farbwiedergabe Ra	90
Optik	Reflektor
Massangaben LED Modul	ø49.8 × 48.7mm
Konverter	115 × 40 × 22mm



Phasenabschnitt dimmbar mit
Feller LED Universaldimmer
40200.LED

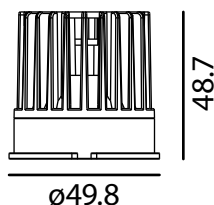

Set mit Konverter	Color Temp	Beam Angle	Light Output	Abstrahlwinkel
740040-27-SET	2700K	40°	460lm	40°
740041-27-SET	2700K	60°	460lm	60°
740040-30-SET	3000K	40°	500lm	40°
740041-30-SET	3000K	60°	500lm	60°
740040-40-SET	4000K	40°	720lm	40°
740041-40-SET	4000K	60°	720lm	60°

6.2W DALI 2 SET Retrofit LED Modul & Konverter



Spannung	220-240V AC, 50Hz (inkl. 350mA Konverter / dimmbar)
Schutzart	IP 20
Schutzklasse:	II

LED	bridgelux. V8
Leistung	6.2W
Farbwiedergabe Ra	90
Optik	Reflektor
Massangaben LED Modul	ø49.8 × 48.7mm
Konverter	111 × 36 × 25mm

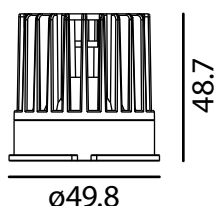

Set mit Konverter	Color Temp	Beam Angle	Light Output	Abstrahlwinkel
New 740040-27-DA	2700K	40°	460lm	40°
New 740041-27-DA	2700K	60°	460lm	60°
New 740040-30-DA	3000K	40°	500lm	40°
New 740041-30-DA	3000K	60°	500lm	60°
New 740040-40-DA	4000K	40°	720lm	40°
New 740041-40-DA	4000K	60°	720lm	60°

9.2W SET Retrofit LED Modul & Konverter

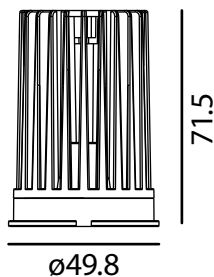
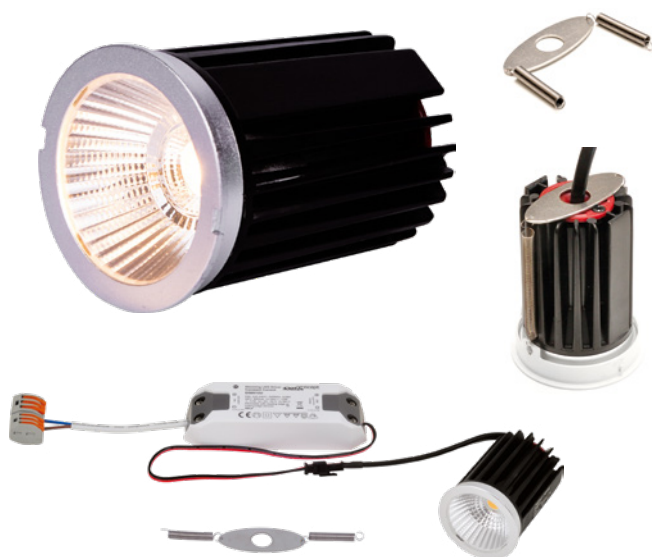

Spannung	220-240V AC, 50Hz (inkl. 500mA Konverter / dimmbar)
Schutzart	IP 20
Schutzklasse:	II

LED	bridgelux. V8
Leistung	9.2W
Farbwiedergabe Ra	90
Optik	Reflektor
Massangaben LED Modul	ø49.8 × 71.5mm
Konverter	115 × 40 × 22mm



Phasenabschnitt dimmbar mit
Feller LED Universaldimmer
40200.LED

Set mit Konverter

Set mit Konverter	Farbtemperatur	Strahlungsart	Leuchtdichte	Abstrahlwinkel
740042-27-SET	2700K	F	863lm	40°
740043-27-SET	2700K	F	863lm	60°
740042-30-SET	3000K	F	883lm	40°
740043-30-SET	3000K	F	883lm	60°
740042-40-SET	4000K	F	974lm	40°
740043-40-SET	4000K	F	974lm	60°

9.2W DALI SET Retrofit LED Modul & Konverter

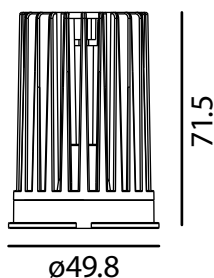

Spannung	220-240V AC, 50Hz (inkl. 500mA Konverter / dimmbar)
Schutzart	IP 20
Schutzklasse:	II

LED	bridgelux. V8
Leistung	9.2W
Farbwiedergabe Ra	90
Optik	Reflektor
Massangaben LED Modul	ø49.8 × 71.5mm
Konverter	111 × 36 × 25mm



Set mit Konverter

Set mit Konverter	Farbtemperatur	Strahlungsart	Leuchtdichte	Abstrahlwinkel
New 740042-27-DA	2700K	F	863lm	40°
New 740043-27-DA	2700K	F	863lm	60°
New 740042-30-DA	3000K	F	883lm	40°
New 740043-30-DA	3000K	F	883lm	60°
New 740042-40-DA	4000K	F	974lm	40°
New 740043-40-DA	4000K	F	974lm	60°

740044 / 740045 – 12.4W Retrofit Modul LED



Strom DC	450mA (Bitte passenden Konverter dazu bestellen)
Schutzart	IP 20
Schutzklasse:	III
LED	bridgelux V10
Leistung	12.4W
Farbwiedergabe Ra	90
Optik	Reflektor
Massangaben	ø49.8 × 71.5mm

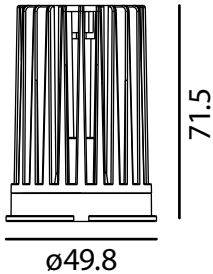

Modell	Farbtemperatur	Effizienz	Lichtstrom	Abstrahlwinkel
740044-27	2700K	AG F	1180lm	40°
740045-27	2700K	AG F	1180lm	60°
740044-30	3000K	AG F	1238lm	40°
740045-30	3000K	AG F	1238lm	60°

740044 / 740045 SET – 12.4W Retrofit LED Modul & Konverter



Spannung	220-240V AC, 50Hz (inkl. 450mA Konverter / dimmbar)
Schutzart	IP 20
Schutzklasse:	II
LED	bridgelux V10
Leistung	12.4W
Farbwiedergabe Ra	90
Optik	Reflektor
Massangaben LED Modul	ø49.8 × 71.5mm
Konverter	120 × 45 × 28mm

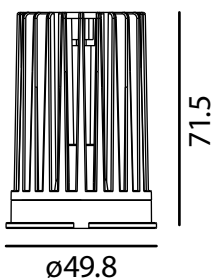

Phasenabschnitt dimmbar mit
Feller LED Universaldimmer
40200.LED

Set mit Konverter	Farbtemperatur	Effizienz	Lichtstrom	Abstrahlwinkel
740044-27-SET	2700K	AG F	11180lm	40°
740045-27-SET	2700K	AG F	11180lm	60°
740044-30-SET	3000K	AG F	11238lm	40°
740045-30-SET	3000K	AG F	11238lm	60°

740044 / 740045 SET – 13W LED Modul Dim to Warm & Konverter



Spannung	220-240V AC, 50Hz (inkl. 310mA Konverter / dimmbar)	
Schutzart	IP 20	
Schutzklasse:	II	
LED	bridgelux	Vesta DTW
Leistung	13W	
Farbwiedergabe Ra	90	
Optik	Reflektor	
Massangaben LED Modul	ø49.8 × 71.5mm	
Konverter	110 × 43 × 26 mm	

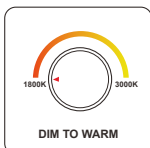

Dim to Warm Funktion nur mit einem PhasenABSchnitt Dimmer möglich.

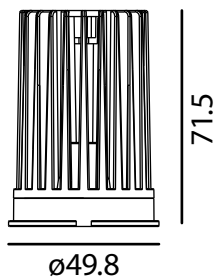

Phasenabschnitt dimmbar mit Feller LED Universaldimmer 40200.LED

Set mit Konverter

740044-50-SET

1800-3000K



940lm

Abstrahlwinkel

40°

740045-50-SET

1800-3000K



940lm

60°

DIM TO WARM 1800 – 3000K





740018 – 5W GU10 LED Retrofit Leuchtmittel

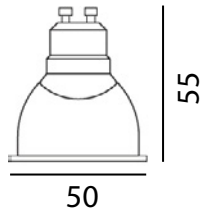

Spannung 220-240V AC, 50Hz
Schutzart IP 20

LED *bridgelux*

Leistung 5W
Farbwiedergabe Ra 80
Dimmbar mit Phasenabschnitt
Optik Linse 38°
Massangaben ø50 × 55mm

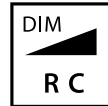

Phasenabschnitt dimmbar mit Feller LED Universaldimmer 40200.LED

740018-27-01	2700K	GA G	380lm	<input type="checkbox"/> weiss
740018-27-75	2700K	GA G	380lm	<input type="checkbox"/> grau
740018-30-01	3000K	FA F	400lm	<input type="checkbox"/> weiss
740018-30-75	3000K	FA F	400lm	<input type="checkbox"/> grau

740018 – 5W GU10 Dim to Warm LED Retrofit Leuchtmittel

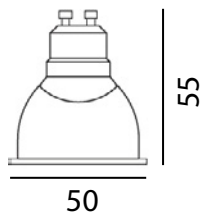

Dim to Warm Funktion
nur mit einem
Phasenabschnitt
Dimmer möglich.

Spannung 220-240V AC, 50Hz
Schutzart IP 20

LED *bridgelux*

Leistung 5W
Farbwiedergabe Ra 80
Dimmbar mit Phasenabschnitt
Optik Linse 38°
Massangaben ø50 × 55mm



Phasenabschnitt dimmbar mit Feller LED Universaldimmer 40200.LED

740018-50-01	2200-3000K	GA G	380lm	<input type="checkbox"/> weiss
740018-50-75	2200-3000K	GA G	380lm	<input type="checkbox"/> grau

230V 12W LED Modul

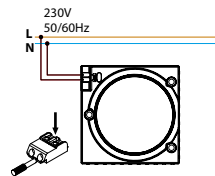
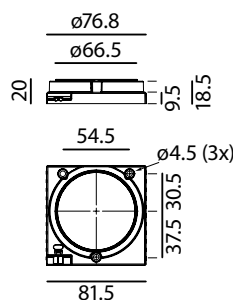
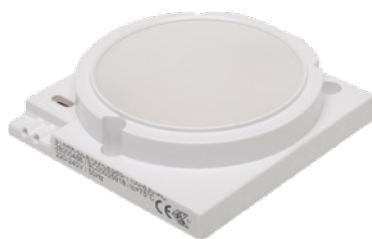

Spannung 230V AC, 50Hz
(nicht dimmbar)

Schutzart IP 00

Schutzklasse:

LED Triodonic

Leistung 12W

Betriebstemperatur ta -30 ... +65° C

tp 65° C

Farbwiedergabe Ra 80

Abstrahlwinkel 80°

Massangaben 81.5 × 81.5mm

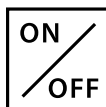

28000486 3000K FA F 1024 lm

Deckeneinbauleuchten





16 74030



16 74031



17 74033



19 74108



21 74184



21 56040

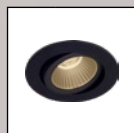

23 74158

[RC] & DALI SET



24 74150



25 74150

[RC] & DALI SET



27 74155/56



28 74155/56

[RC] & DALI SET



New

31 74158

Tunable White

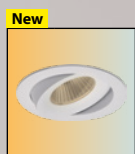

New

31 74155/56

Tunable White



New

32 74176

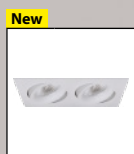

New

33 74176



35 59023

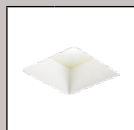

37 59025

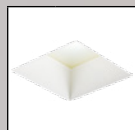

37 59027



39 59020



39 59022



41 59030

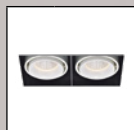

41 59031



43 59028



43 59029

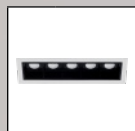

45 59052

Line 5

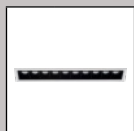

45 59053

Line 10



47 59040

Line 5 JS



47 59041

Line 10 JS



48 74042



48 74043



49 74044



49 74046

74030 – 4W Einbaustrahler LED IP44

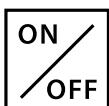
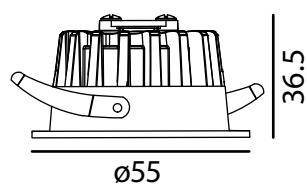

74030-27-00	2700K	AGG	300lm	<input type="checkbox"/> weiss matt
74030-27-02	2700K	AGG	300lm	<input type="checkbox"/> schwarz matt
74030-30-00	3000K	AGF	330lm	<input type="checkbox"/> weiss matt
74030-30-02	3000K	AGF	330lm	<input type="checkbox"/> schwarz matt

Zubehör

730115-350	Konverter 11W 103×37×25mm
35200	Einbaugehäuse AS ø0–70mm



Spannung 220-240V AC, 50Hz
(inkl. 350mA Konverter / nicht dimmbar)

Schutzart IP 44

Schutzklasse: II

LED **CREE**

Leistung 4W

Farbwiedergabe Ra 90

Optik Reflektor 24° Schutzglas klar

Material Gehäuse Alu Druckguss

Einbau Blattfedern

Ausschnitt / Einbautiefe AS ø46–50mm / ET 45mm

Massangaben ø55 × 36.5mm

74031 – 4W Einbaustrahler LED IP44

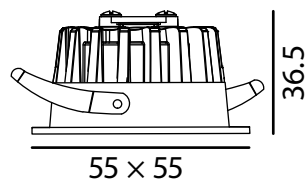

74031-27-00	2700K	AGG	300lm	<input type="checkbox"/> weiss matt
74031-30-00	3000K	AGF	330lm	<input type="checkbox"/> weiss matt

Zubehör

730115-350	Konverter 11W 103×37×25mm
35200	Einbaugehäuse AS ø0–70mm



Spannung 220-240V AC, 50Hz
(inkl. 350mA Konverter / nicht dimmbar)

Schutzart IP 44

Schutzklasse: II

LED **CREE**

Leistung 4W

Farbwiedergabe Ra 90

Optik Reflektor 24° Schutzglas klar

Material Gehäuse Alu Druckguss

Einbau Blattfedern

Ausschnitt / Einbautiefe AS ø46–50mm / ET 45mm

Massangaben 55 × 55 × 36.5mm

74033 – 4W Einbaustrahler LED IP44

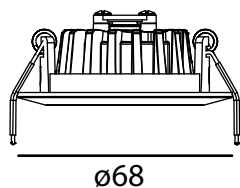

ø68

36.5

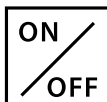

Spannung 220-240V AC, 50Hz
(inkl. 350mA Konverter / nicht dimmbar)

Schutzart IP 44

Schutzklasse: II

LED **CREE**

Leistung 4W

Farbwiedergabe Ra 90

Optik Reflektor 25° Schutzglas klar

Schwenkbar 30°

Material Gehäuse Alu Druckguss

Einbau Spreizfedern

Ausschnitt / Einbautiefe AS ø54-58mm / ET 45mm

Massangaben ø68 × 36.5mm

74033-27-00

2700K



300lm

weiss matt

74033-27-02

2700K



300lm

schwarz matt

74033-30-00

3000K



330lm

weiss matt

74033-30-02

3000K



330lm

schwarz matt

Zubehör

730115-350



Konverter | 11W | 103×37×25mm

35200

Einbaugehäuse AS ø0-70mm





74108 – 6.1W Einbaustrahler für 50mm Ausschnitt IP44

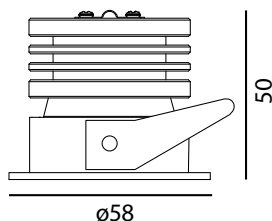

Strom DC	350mA (Bitte passenden Konverter dazu bestellen)
Schutzart	IP 44
Schutzklasse:	III
LED	bridgelux V8 Gen 7
Leistung	6.1W
Farbwiedergabe Ra	90
Optik	Linse
Schwenkbar	30°
Material Gehäuse	Aluminium
Einbau	Spreizfedern
Ausschnitt / Einbautiefe	AS ø50mm / ET 50mm
Massangaben	ø95 × 35mm

						Abstrahlwinkel
74108-36-27-00	2700K		727lm	<input type="checkbox"/> weiss matt		36°
74108-36-27-02	2700K		727lm	<input type="checkbox"/> schwarz matt		36°
74108-36-30-00	3000K		757lm	<input type="checkbox"/> weiss matt		36°
74108-36-30-02	3000K		757lm	<input type="checkbox"/> schwarz matt		36°

Zubehör

730050-09U	Konverter dim [RC] 350mA 4-9W 115×40×22mm
730115-350	Konverter 11W 103×37×25mm



74184 – 9.2W Einbaustrahler LED

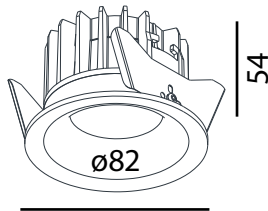

Strom DC	500mA (Bitte passenden Konverter dazu bestellen)
Schutzart	IP 20
Schutzklasse:	III
LED	bridgelux. V8
Leistung	9.2W
Farbwiedergabe Ra	90
Optik	Reflektor 32° Schutzglas klar
Material Gehäuse	Alu Druckguss
Montage	Blattfedern
Ausschnitt / Einbautiefe	AS ø70mm / ET 70
Massangaben	ø82 × 54mm

74184-27-00	2700K		863lm	<input type="checkbox"/> weiss matt
74184-27-02	2700K		863lm	<input checked="" type="checkbox"/> schwarz matt
74184-30-00	3000K		883lm	<input type="checkbox"/> weiss matt
74184-30-02	3000K		883lm	<input checked="" type="checkbox"/> schwarz matt

Zubehör

730051-12U	Konverter dim [RC] 500mA 6-12W 115×40×22mm
730115-500	Konverter 10W 103×37×25mm

56040 – 9.2W Halbeinbaustrahler

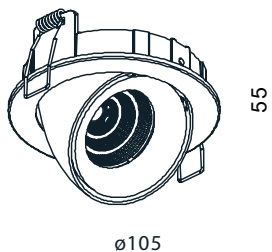

Strom DC	500mA (Bitte passenden Konverter dazu bestellen)
Schutzart	IP 20
Schutzklasse:	III
LED	bridgelux. V8
Leistung	9.2W
Farbwiedergabe Ra	90
Optik	Reflektor 45° Schutzglas klar
Dreh- und schwenkbar	35° / 45°
Material Gehäuse	Aluminium
Einbau	Spreizfedern
Ausschnitt / Einbautiefe	AS ø95mm / ET 70mm
Massangaben	ø105 × 55mm

56040-27-00	2700K		863lm	<input type="checkbox"/> weiss matt
56040-27-02	2700K		863lm	<input checked="" type="checkbox"/> schwarz matt
56040-27-75	2700K		863lm	<input type="checkbox"/> silberfarbig
56040-30-00	3000K		883lm	<input type="checkbox"/> weiss matt
56040-30-02	3000K		883lm	<input checked="" type="checkbox"/> schwarz matt
56040-30-75	3000K		883lm	<input type="checkbox"/> silberfarbig

Zubehör

730051-12U	Konverter dim [RC] 500mA 6-12W 115×40×22mm
730115-500	Konverter 10W 103×37×25mm
205095	Einbaugehäuse mit Tank AS ø95mm

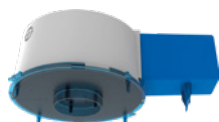



74158 – 8.9W Einbaustrahler SET IP44

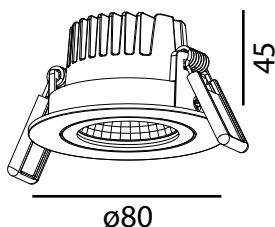
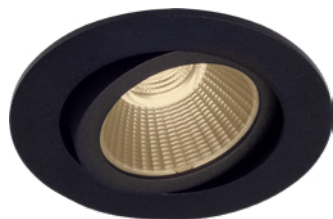

Phasenabschnitt dimmbar mit
Feller LED Universaldimmer
40200.LED



Spannung	220-240V AC, 50Hz (inkl. 500mA Konverter / dimmbar)
Schutzart	IP 44
Schutzklasse:	III
LED	bridgelux. V8 Gen 7
Leistung	8.9W
Farbwiedergabe Ra	90
Optik	Reflektor, Schutzglas klar
Schwenkbar	20°
Material Gehäuse	Aluminium
Einbau	Spreizfedern
Ausschnitt / Einbautiefe	AS ø68mm / ET 60mm
Massangaben Strahler	ø80 × 45mm
Konverter	115 × 40 × 22mm

Modell	Temperatur	Effizienz	Leistung	Farbwiedergabe	Optik	Schwenkbar	Material Gehäuse	Einbau	Ausschnitt / Einbautiefe	Massangaben Strahler	Konverter	Abstrahlwinkel
74158-27-36-00-ST	2700K	A E	1011lm	weiss matt	Reflektor, Schutzglas klar	20°	Aluminium	Spreizfedern	AS ø68mm / ET 60mm	ø80 × 45mm	115 × 40 × 22mm	36°
74158-27-36-02-ST	2700K	A E	1011lm	schwarz matt	Reflektor, Schutzglas klar	20°	Aluminium	Spreizfedern	AS ø68mm / ET 60mm	ø80 × 45mm	115 × 40 × 22mm	36°
74158-30-36-00-ST	3000K	A E	1051lm	weiss matt	Reflektor, Schutzglas klar	20°	Aluminium	Spreizfedern	AS ø68mm / ET 60mm	ø80 × 45mm	115 × 40 × 22mm	36°
74158-30-36-02-ST	3000K	A E	1051lm	schwarz matt	Reflektor, Schutzglas klar	20°	Aluminium	Spreizfedern	AS ø68mm / ET 60mm	ø80 × 45mm	115 × 40 × 22mm	36°
74158-27-60-00-ST	2700K	A E	1011lm	weiss matt	Reflektor, Schutzglas klar	20°	Aluminium	Spreizfedern	AS ø68mm / ET 60mm	ø80 × 45mm	115 × 40 × 22mm	60°
74158-27-60-02-ST	2700K	A E	1011lm	schwarz matt	Reflektor, Schutzglas klar	20°	Aluminium	Spreizfedern	AS ø68mm / ET 60mm	ø80 × 45mm	115 × 40 × 22mm	60°
74158-30-60-00-ST	3000K	A E	1051lm	weiss matt	Reflektor, Schutzglas klar	20°	Aluminium	Spreizfedern	AS ø68mm / ET 60mm	ø80 × 45mm	115 × 40 × 22mm	60°
74158-30-60-02-ST	3000K	A E	1051lm	schwarz matt	Reflektor, Schutzglas klar	20°	Aluminium	Spreizfedern	AS ø68mm / ET 60mm	ø80 × 45mm	115 × 40 × 22mm	60°

74158-DA – 8.9W Einbaustrahler SET IP44

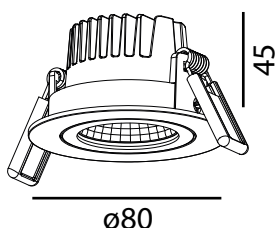

Spannung	220-240V AC, 50Hz (inkl. 500mA Konverter / dimmbar)
Schutzart	IP 44
Schutzklasse:	III
LED	bridgelux. V8 Gen 7
Leistung	8.9W
Farbwiedergabe Ra	90
Optik	Reflektor, Schutzglas klar
Schwenkbar	20°
Material Gehäuse	Aluminium
Einbau	Spreizfedern
Ausschnitt / Einbautiefe	AS ø68mm / ET 60mm
Massangaben Strahler	ø80 × 45mm
Konverter	111 × 36 × 25mm

Modell	Temperatur	Effizienz	Leistung	Farbwiedergabe	Optik	Schwenkbar	Material Gehäuse	Einbau	Ausschnitt / Einbautiefe	Massangaben Strahler	Konverter	Abstrahlwinkel
74158-27-36-00 DA	2700K	A E	1011lm	weiss matt	Reflektor, Schutzglas klar	20°	Aluminium	Spreizfedern	AS ø68mm / ET 60mm	ø80 × 45mm	111 × 36 × 25mm	36°
74158-27-36-02 DA	2700K	A E	1011lm	schwarz matt	Reflektor, Schutzglas klar	20°	Aluminium	Spreizfedern	AS ø68mm / ET 60mm	ø80 × 45mm	111 × 36 × 25mm	36°
74158-30-36-00 DA	3000K	A E	1051lm	weiss matt	Reflektor, Schutzglas klar	20°	Aluminium	Spreizfedern	AS ø68mm / ET 60mm	ø80 × 45mm	111 × 36 × 25mm	36°
74158-30-36-02 DA	3000K	A E	1051lm	schwarz matt	Reflektor, Schutzglas klar	20°	Aluminium	Spreizfedern	AS ø68mm / ET 60mm	ø80 × 45mm	111 × 36 × 25mm	36°
74158-27-60-00 DA	2700K	A E	1011lm	weiss matt	Reflektor, Schutzglas klar	20°	Aluminium	Spreizfedern	AS ø68mm / ET 60mm	ø80 × 45mm	111 × 36 × 25mm	60°
74158-27-60-02 DA	2700K	A E	1011lm	schwarz matt	Reflektor, Schutzglas klar	20°	Aluminium	Spreizfedern	AS ø68mm / ET 60mm	ø80 × 45mm	111 × 36 × 25mm	60°
74158-30-60-00 DA	3000K	A E	1051lm	weiss matt	Reflektor, Schutzglas klar	20°	Aluminium	Spreizfedern	AS ø68mm / ET 60mm	ø80 × 45mm	111 × 36 × 25mm	60°
74158-30-60-02 DA	3000K	A E	1051lm	schwarz matt	Reflektor, Schutzglas klar	20°	Aluminium	Spreizfedern	AS ø68mm / ET 60mm	ø80 × 45mm	111 × 36 × 25mm	60°

74150 – 6.1W 35mm Einbaustrahler IP44

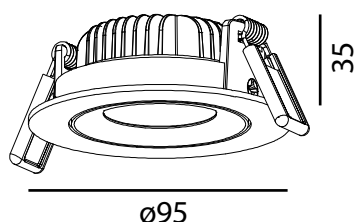
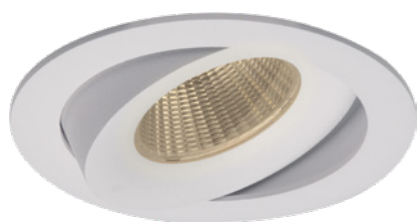

ø95

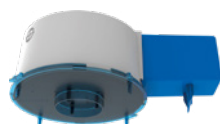

Strom DC	350mA
	(Bitte passenden Konverter dazu bestellen)
Schutzart	IP 44
Schutzklasse:	III
LED	bridgelux. V8 Gen 7
Leistung	6.1W
Farbwiedergabe Ra	90
Optik	Reflektor, Schutzglas klar
Schwenkbar	20°
Material Gehäuse	Aluminium
Einbau	Spreizfedern
Ausschnitt / Einbautiefe	AS ø80mm / ET 50mm
Massangaben	ø95 × 35mm

					Abstrahlwinkel
74150-27-00	2700K	A E	727lm	<input type="checkbox"/> weiss matt	36°
74150-30-00	3000K	A D	757lm	<input type="checkbox"/> weiss matt	36°

Zubehör

74150-RF15	15° Reflektor
74150-RF24	24° Reflektor
74150-RF60	60° Reflektor
205080	Einbaugehäuse mit Tank AS ø80mm



74155 / 74156 – 8.9W 50mm Einbaustrahler IP44



Strom DC	500mA (Bitte passenden Konverter dazu bestellen)
Schutzart	IP 44
Schutzklasse:	III
LED	bridgelux V8 Gen 7
Leistung	8.9W
Farbwiedergabe Ra	90
Optik	Reflektor, Schutzglas klar
Schwenkbar	20°
Material Gehäuse	Aluminium
Einbau	Spreizfedern
Ausschnitt / Einbautiefe	AS ø80mm / ET 70mm
Massangaben	ø95 × 50mm

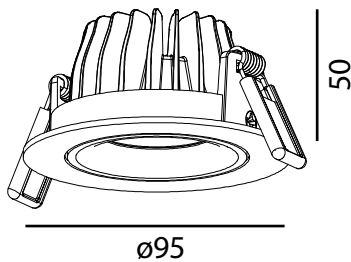

ø95

50

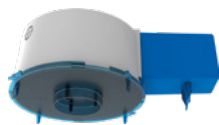

						Abstrahlwinkel
74155-27-00	2700K		1011lm		weiss matt	36°
74155-27-02	2700K		1011lm		schwarz	36°
74155-30-00	3000K		1051lm		weiss matt	36°
74155-30-02	3000K		1051lm		schwarz	36°
74155-40-00	4000K		1126lm		weiss matt	36°
74156-27-00	2700K		1011lm		weiss matt	60°
74156-27-02	2700K		1011lm		schwarz	60°
74156-30-00	3000K		1051lm		weiss matt	60°
74156-30-02	3000K		1051lm		schwarz	60°
74156-40-00	4000K		1126lm		weiss matt	60°

Zubehör

74150-RF15	15° Reflektor für Lens Anbaustrahler
74150-RF24	24° Reflektor für Lens Anbaustrahler
205080	Einbaugehäuse mit Tank AS ø80mm

74155 / 74156 – 8.9W 50mm Einbaustrahler SET IP44



Phasenabschnitt dimmbar mit
Feller LED Universaldimmer
40200.LED

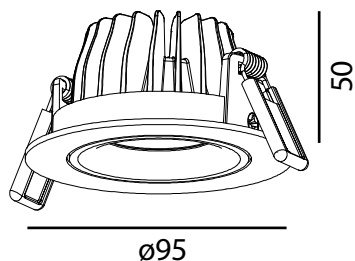

Spannung	220-240V AC, 50Hz (inkl. 500mA Konverter / dimmbar)
Schutzart	IP 44
Schutzklasse:	III
LED	bridgelux V8 Gen 7
Leistung	8.9W
Farbwiedergabe Ra	90
Optik	Reflektor, Schutzglas klar
Schwenkbar	20°
Material Gehäuse	Aluminium
Einbau	Spreizfedern
Ausschnitt / Einbautiefe	AS ø80mm / ET 70mm
Massangaben Strahler	ø95 × 50mm
Konverter	115 × 40 × 22mm

Modell	Farbtemperatur	Effizienz	Flussdichte	Farbwiedergabe	Abstrahlwinkel
74155-27-00-SET	2700K	A+ E	1011lm	weiss matt	36°
74155-27-02-SET	2700K	A+ E	1011lm	schwarz matt	36°
74155-30-00-SET	3000K	A+ E	1051lm	weiss matt	36°
74155-30-02-SET	3000K	A+ E	1051lm	schwarz matt	36°
74156-27-00-SET	2700K	A+ E	1011lm	weiss matt	60°
74156-27-02-SET	2700K	A+ E	1011lm	schwarz matt	60°
74156-30-00-SET	3000K	A+ E	1051lm	weiss matt	60°
74156-30-02-SET	3000K	A+ E	1051lm	schwarz matt	60°

74155-DA / 74156-DA – 8.9W 50mm Einbaustrahler DALI SET IP44

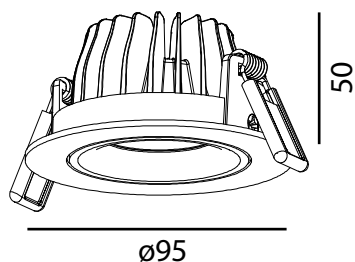
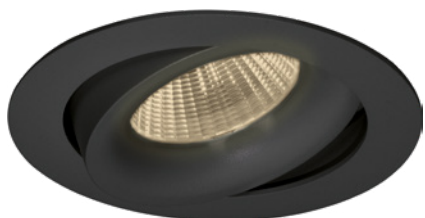

Spannung	220-240V AC, 50Hz (inkl. 500mA Konverter / dimmbar)
Schutzart	IP 44
Schutzklasse:	III
LED	bridgelux V8 Gen 7
Leistung	8.9W
Farbwiedergabe Ra	90
Optik	Reflektor, Schutzglas klar
Schwenkbar	20°
Material Gehäuse	Aluminium
Einbau	Spreizfedern
Ausschnitt / Einbautiefe	AS ø80mm / ET 70mm
Massangaben Strahler	ø95 × 50mm
Konverter	111 × 36 × 25mm

Modell	Farbtemperatur	Effizienz	Flussdichte	Farbwiedergabe	Abstrahlwinkel
74155-27-00 DA	2700K	A+ E	1011lm	weiss matt	36°
74155-27-02 DA	2700K	A+ E	1011lm	schwarz matt	36°
74155-30-00 DA	3000K	A+ E	1051lm	weiss matt	36°
74155-30-02 DA	3000K	A+ E	1051lm	schwarz matt	36°
74156-27-00 DA	2700K	A+ E	1011lm	weiss matt	60°
74156-27-02 DA	2700K	A+ E	1011lm	schwarz matt	60°
74156-30-00 DA	3000K	A+ E	1051lm	weiss matt	60°
74156-30-02 DA	3000K	A+ E	1051lm	schwarz matt	60°

74155 / 74156 BF – 8.9W 50mm Einbaustrahler SET IP44 Blattfeder Variante

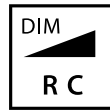

Phasenabschnitt dimmbar mit
Feller LED Universaldimmer
40200.LED

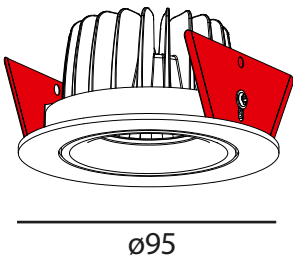

						Abstrahlwinkel
New	74155-27-00 BF ST	2700K			1011lm	<input type="checkbox"/> weiss matt 36°
New	74155-30-00 BF ST	3000K			1051lm	<input type="checkbox"/> weiss matt 36°
New	74156-27-00 BF ST	2700K			1011lm	<input type="checkbox"/> weiss matt 60°
New	74156-30-00 BF ST	3000K			1051lm	<input type="checkbox"/> weiss matt 60°



Spannung	220-240V AC, 50Hz (inkl. 500mA Konverter / dimmbar)	
Schutzart	IP 44	
Schutzklasse:	III	
LED	bridgelux.	V8 Gen 7
Leistung	8.9W	
Farbwiedergabe Ra	90	
Optik	Reflektor, Schutzglas klar	
Schwenkbar	20°	
Material Gehäuse	Aluminium	
Einbau	Blattfedern	
Ausschnitt / Einbautiefe	AS ø80mm / ET 70mm	
Massangaben Strahler	ø95 × 50mm	
Konverter	115 × 40 × 22mm	

74155 / 74156 BF DA – 8.9W 50mm Einbaustrahler SET IP44 Blattfeder Variante

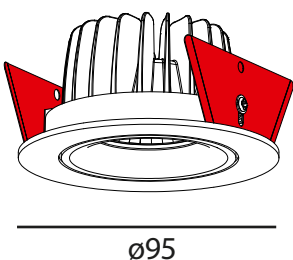

						Abstrahlwinkel
New	74155-27-00 BF DA	2700K			1011lm	<input type="checkbox"/> weiss matt 36°
New	74155-30-00 BF DA	3000K			1051lm	<input type="checkbox"/> weiss matt 36°
New	74156-27-00 BF DA	2700K			1011lm	<input type="checkbox"/> weiss matt 60°
New	74156-30-00 BF DA	3000K			1051lm	<input type="checkbox"/> weiss matt 60°



Spannung	220-240V AC, 50Hz (inkl. 500mA Konverter / dimmbar)	
Schutzart	IP 44	
Schutzklasse:	III	
LED	bridgelux.	V8 Gen 7
Leistung	8.9W	
Farbwiedergabe Ra	90	
Optik	Reflektor, Schutzglas klar	
Schwenkbar	20°	
Material Gehäuse	Aluminium	
Einbau	Blattfedern	
Ausschnitt / Einbautiefe	AS ø80mm / ET 70mm	
Massangaben Strahler	ø95 × 50mm	
Konverter	111 × 36 × 25mm	

Tunable White

Betriebsart DALI DT8

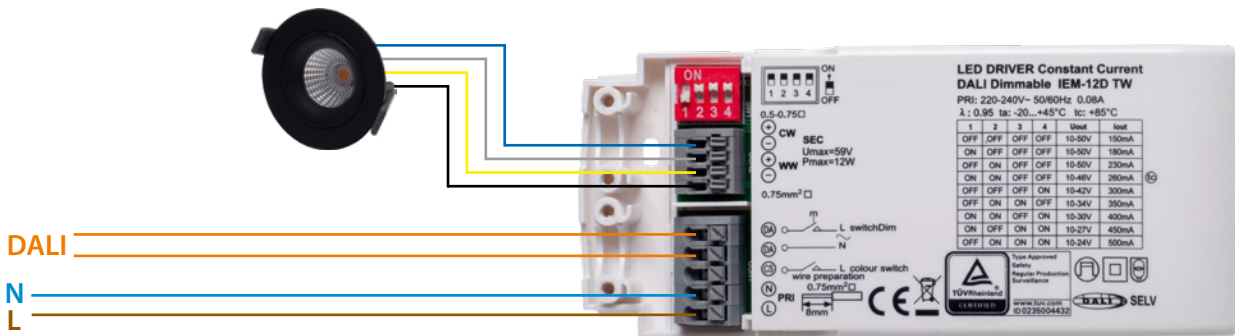

Feller Drehdimmer

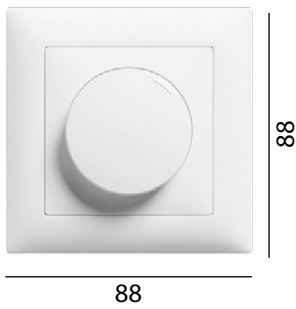

Schutzart	IP20
Stromversorgung	230 V
DALI Steuerstrom	56mA
FürDALI Protokoll	DT6 / DT8 Tc
Eingabeoptionen	Drehen / Drücken / Halten / 2 × Drücken
Speicher	Minimale Helligkeit / Einschaltelligkeit
Abmessungen	88 × 88 × 34mm

Anzahl von DALI Geräten	Broadcast	DALI Adressen	DALI Gruppen	Dim	CCT	RGBW
27	✓	—	—	✓	✓	—

FE 548502000

weiss

DALI Drehdimmer DT8 Tc

FE 548010950

schwarz

DALI Drehdimmer DT8 Tc

74158-50 DA – 8.9W CCT Einbaustrahler SET IP44 Blattfeder Variante

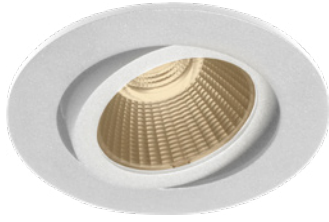

Tunable White

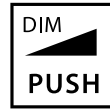

DALI DT8 dimmbar mit
Feller Power-Drehgeber TW
40085.DALI

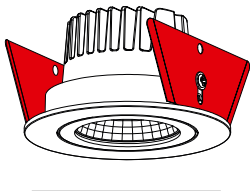

New	74158-50-36-00 DA	1800–4000K		1011lm	<input type="checkbox"/> weiss matt	36°
New	74158-50-60-00 DA	1800–4000K		1011lm	<input type="checkbox"/> weiss matt	60°

ø80



Spannung	220-240V AC, 50Hz (inkl. 500mA Konverter / dimmbar)	
Schutzart	IP 44	
Schutzklasse:	III	
LED	bridgelux.	V8 Gen 7
Leistung	8.9W	
Farbwiedergabe Ra	90	
Optik	Reflektor, Schutzglas klar	
Schwenkbar	20°	
Material Gehäuse	Aluminium	
Einbau	Blattfedern	
Ausschnitt / Einbautiefe	AS ø68mm / ET 60mm	
Massangaben Strahler	ø80 × 45mm	
Konverter	120 × 52 × 23mm	

74155-50 / 74156-50 DA – 8.9W CCT Einbaustrahler SET IP44



Tunable White



DALI DT8 dimmbar mit
Feller Power-Drehgeber TW
40085.DALI

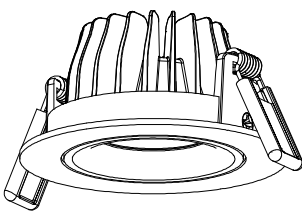

New	74155-50-00 DA	1800–4000K		1011lm	<input type="checkbox"/> weiss matt	36°
New	74155-50-02 DA	1800–4000K		1011lm	<input checked="" type="checkbox"/> schwarz matt	36°
New	74156-50-00 DA	1800–4000K		1011lm	<input type="checkbox"/> weiss matt	60°
New	74156-50-02 DA	1800–4000K		1011lm	<input checked="" type="checkbox"/> schwarz matt	60°

ø95



Spannung	220-240V AC, 50Hz (inkl. 500mA Konverter / dimmbar)	
Schutzart	IP 44	
Schutzklasse:	III	
LED	bridgelux.	V8 Gen 7
Leistung	8.9W	
Farbwiedergabe Ra	90	
Optik	Reflektor, Schutzglas klar	
Schwenkbar	20°	
Material Gehäuse	Aluminium	
Einbau	Spreizfedern	
Ausschnitt / Einbautiefe	AS ø80mm / ET 70mm	
Massangaben Strahler	ø95 × 50mm	
Konverter	120 × 52 × 23mm	

74176 – 8.9W Einbaustrahler kardanisch Sets IP44

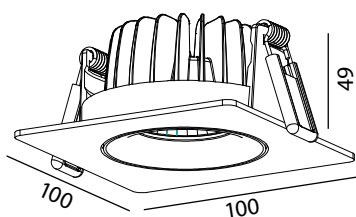
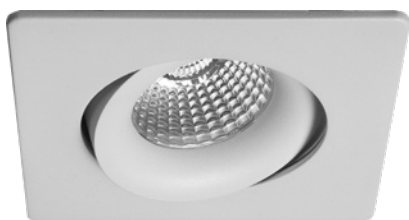

Strom DC	500mA
Schutzart	IP 44
Schutzklasse:	III
LED	bridgelux V8 Gen 7
Leistung	8.9W
Farbwiedergabe Ra	90
Optik	Reflektor, Schutzglas klar
Dreh- und schwenkbar	40° / 360°
Material Gehäuse	Aluminium
Einbau	Spreizfedern
Ausschnitt / Einbautiefe	AS ø85mm / ET 70mm
Massangaben	100 × 100 × 49mm



					Abstrahlwinkel
New	74176-27-00 SET	2700K	A A E	1011lm	weiss matt 60°
New	74176-30-00 SET	3000K	A A E	1051lm	weiss matt 60°



					Abstrahlwinkel
New	74176-27-00 DA	2700K	A A E	1011lm	weiss matt 60°
New	74176-27-02 DA	2700K	A A E	1011lm	schwarz 60°
New	74176-30-00 DA	3000K	A A E	1051lm	weiss matt 60°
New	74176-30-02 DA	3000K	A A E	1051lm	schwarz 60°



Tunable White ❄️



					Abstrahlwinkel
New	74176-50-00 DA	1800–4000K	A A E	1011lm	weiss matt 60°
New	74176-50-02 DA	1800–4000K	A A E	1011lm	schwarz matt 60°

74276 – 2 × 8.9W Einbaustrahler kardanisich Sets IP44



Strom DC	500mA
	(Bitte passenden Konverter dazu bestellen)
Schutzart	IP 44
Schutzklasse:	III
LED	bridgelux V8 Gen 7
Leistung	2 × 8.9W
Farbwiedergabe Ra	90
Optik	Reflektor, Schutzglas klar
Dreh- und schwenkbar	40° / 360°
Material Gehäuse	Aluminium
Einbau	Spreizfedern
Ausschnitt / Einbautiefe	AS 85 × 170mm / ET 70mm
Massangaben	100 × 100 × 49mm

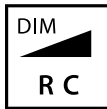
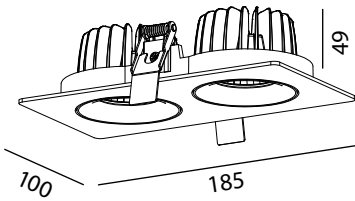

New	74276-27-00 ST	2700K		2 × 1011lm	<input type="checkbox"/> weiss matt	Abstrahlwinkel 60°
New	74276-30-00 ST	3000K		2 × 1051lm	<input type="checkbox"/> weiss matt	60°

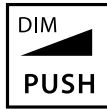

New	74276-27-00 DA	2700K		2 × 1011lm	<input type="checkbox"/> weiss matt	Abstrahlwinkel 60°
New	74276-27-02 DA	2700K		2 × 1011lm	<input checked="" type="checkbox"/> schwarz	60°
New	74276-30-00 DA	3000K		2 × 1051lm	<input type="checkbox"/> weiss matt	60°
New	74276-30-02 DA	3000K		2 × 1051lm	<input checked="" type="checkbox"/> schwarz	60°



New	74276-50-00 DA	1800–4000K		2 × 1011lm	<input type="checkbox"/> weiss matt	Abstrahlwinkel 60°
New	74276-50-02 DA	1800–4000K		2 × 1011lm	<input checked="" type="checkbox"/> schwarz matt	60°



59023 – 9.2W Einbaustrahler starr randlos

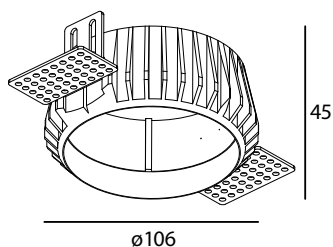

Inklusive Montagerahmen

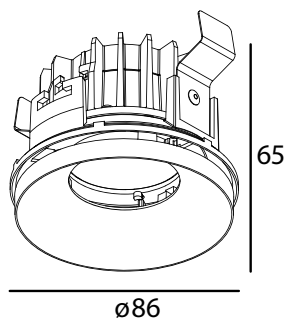

59023-27-00	2700K		863lm	<input type="checkbox"/> weiss matt
59023-30-00	3000K		883lm	<input type="checkbox"/> weiss matt

Zubehör

730051-12U	Konverter dim [RC] 500mA 6-12W 115×40×22mm
730115-500	Konverter 29W 145×46×31mm
59023-EB	Einbaugehäuse AS ø114mm



Strom DC	500mA (Bitte passenden Konverter dazu bestellen)
Schutzart	IP 20
Schutzklasse:	III
LED	V8
Leistung	9.2W
Farbwiedergabe Ra	90
Optik	Reflektor 45° Schutzglas klar
Material Gehäuse	Aluminium
Einbau	Montagerahmen
Ausschnitt / Einbautiefe	AS ø114mm / ET 85mm
Massangaben	ø86 × 65mm

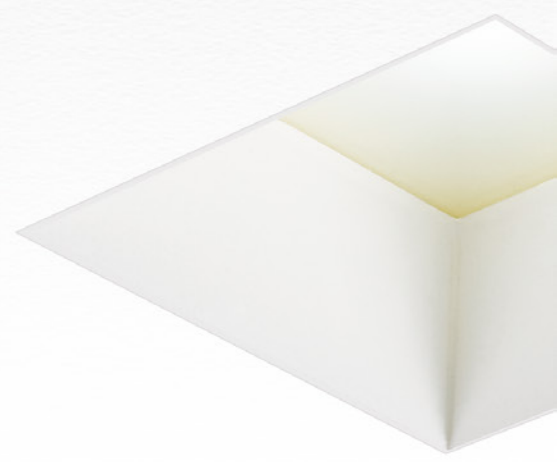
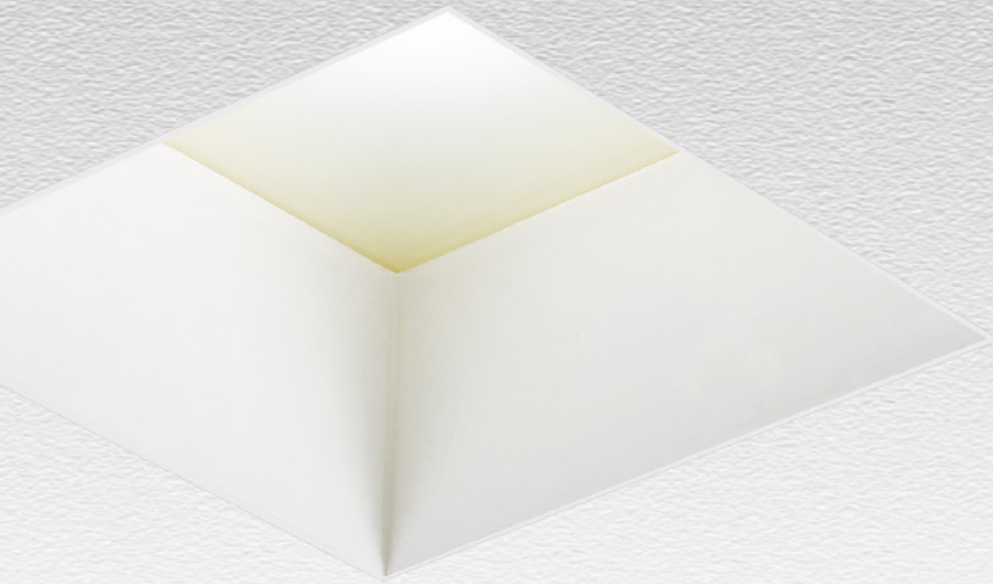

59025 – 9.8W Einbaustrahler LED randlos

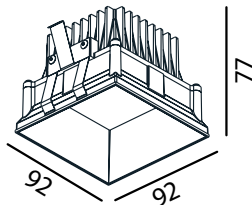
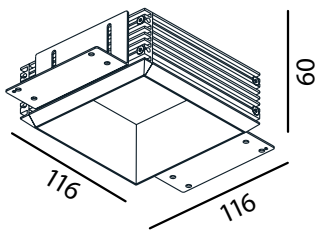
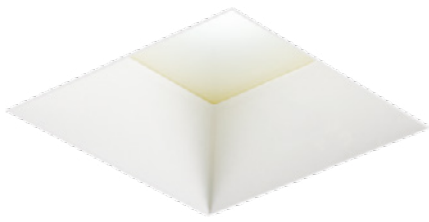

59025-27-00	2700K		912lm	<input type="checkbox"/>	weiss matt
59025-30-00	3000K		950lm	<input type="checkbox"/>	weiss matt
59025-40-00	4000K		1210lm	<input type="checkbox"/>	weiss matt

Zubehör

730051-12U	Konverter dim [RC] 500mA 6-12W 115×40×22mm
730115-500	Konverter 10W 103×37×25mm
59025-EB	Einbaugehäuse



Strom DC **500mA**
(Bitte passenden Konverter dazu bestellen)

Schutzart IP 20

Schutzklasse: III

LED **PHILIPS** LUXEON

Leistung 9.8W

Farbwiedergabe Ra 80

Optik PMMA Opal Abdeckung

Material Gehäuse Aluminium

Einbau Montage Rahmen randlos

Ausschnitt / Einbautiefe AS 118 × 118mm / ET 100

Massangaben 92 × 92 × 77mm

• Inklusive Montage Rahmen für den Deckeneinbau

59027 – 16.2W Einbaustrahler LED randlos

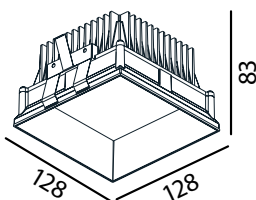
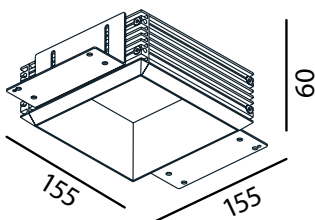
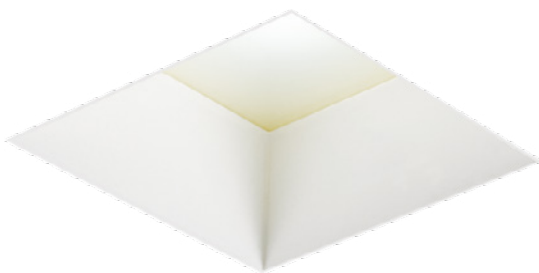

59027-27-00	2700K		1480lm	<input type="checkbox"/>	weiss matt
59027-30-00	3000K		1539lm	<input type="checkbox"/>	weiss matt
59027-40-00	4000K		1712lm	<input type="checkbox"/>	weiss matt

Zubehör

730048	Konverter dim [RC] 500mA 5-18W 113×44×28mm
730120	Konverter 29W 145×46×31mm
59027-EB	Einbaugehäuse



Strom DC **500mA**
(Bitte passenden Konverter dazu bestellen)

Schutzart IP 20

Schutzklasse: III

LED **PHILIPS** LUXEON

Leistung 16.2W

Farbwiedergabe Ra 80

Optik PMMA Opal Abdeckung

Material Gehäuse Aluminium

Einbau Montage Rahmen randlos

Ausschnitt / Einbautiefe AS 154 × 154mm / ET 110

Massangaben 128 × 128 × 83mm

• Inklusive Montage Rahmen für den Deckeneinbau



59020 – 9.2W Einbaustrahler

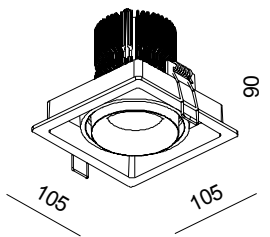

59020-27-12	2700K		863lm		weiss matt / schwarz
59020-27-14	2700K		863lm		silberfarbig / schwarz
59020-30-12	3000K		883lm		weiss matt / schwarz
59020-30-14	3000K		883lm		silberfarbig / schwarz

Zubehör

730051-12U	Konverter dim [RC] 500mA 6-12W 115×40×22mm
730115-500	Konverter 10W 103×37×25mm
205400 93	Einbaugehäuse mit Tank AS 93×93mm



Strom DC	500mA (Bitte passenden Konverter dazu bestellen)
Schutzart	IP 20
Schutzklasse:	III
LED	bridgelux. V8
Leistung	9.2W
Farbwiedergabe Ra	90
Optik	Reflektor 45° Schutzglas klar
Dreh- und schwenkbar	35° / 22°
Material Gehäuse	Aluminium
Einbau	Spreizfedern
Ausschnitt / Einbautiefe	AS 93 × 93mm / ET 116mm
Massangaben	105 × 105 × 90mm

59022 – 2 × 9.2W Einbaustrahler

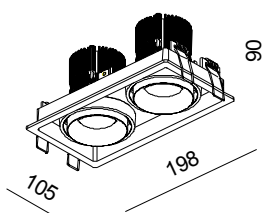

59022-27-12	2700K		2 × 863lm		weiss matt / schwarz
59022-27-14	2700K		2 × 863lm		silberfarbig / schwarz
59022-30-12	3000K		2 × 883lm		weiss matt / schwarz
59022-30-14	3000K		2 × 883lm		silberfarbig / schwarz

Zubehör

73142	Konverter dim [RC] 500mA 10-22W 127×44×28mm
730120-500	Konverter 29W Leuchten in Serie schalten!
310400-185	Einbaugehäuse AS 93×185mm



Strom DC	500mA (Bitte passenden Konverter dazu bestellen)
Schutzart	IP 20
Schutzklasse:	III
LED	bridgelux. V8
Leistung	2 × 9.2W
Farbwiedergabe Ra	90
Optik	Reflektor 45° Schutzglas klar
Dreh- und schwenkbar	35° / 22°
Material Gehäuse	Aluminium
Einbau	Spreizfedern
Ausschnitt / Einbautiefe	AS 93 × 185mm / ET 116mm
Massangaben	198 × 105 × 90mm



59030 – 9.2W Einbaustrahler LED randlos

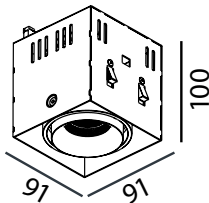
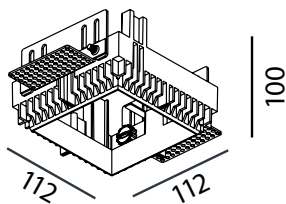

59030-27-00	2700K		863lm		weiss matt
59030-27-12	2700K		863lm		weiss / schwarz
59030-30-00	3000K		883lm		weiss matt
59030-30-12	3000K		883lm		weiss / schwarz

Zubehör

730051-U	Konverter dim [RC] 500mA 6-12W 115×40×22mm
730115-500	Konverter 10W 103×37×25mm
59030-EB	Einbaugehäuse



Strom DC **500mA**
(Bitte passenden Konverter dazu bestellen)

Schutzart IP 20

Schutzklasse: III

LED V8

Leistung 9.2W

Farbwiedergabe Ra 90

Optik Reflektor 45° Schutzglas

Material Gehäuse Aluminium

Einbau Montage Rahmen randlos

Ausschnitt / Einbautiefe AS 114 × 114mm / ET 116

Massangaben 91 × 91 × 96mm

• Inklusive Montage Rahmen für den Deckeneinbau

59031 – 2 × 9.2W Einbaustrahler LED randlos

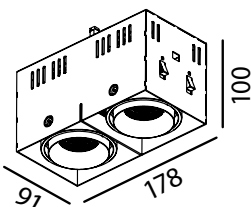
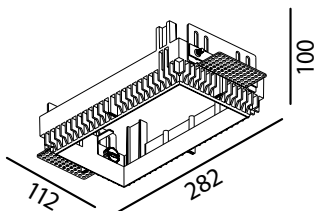

59031-27-00	2700K		2 × 863lm		weiss matt
59031-27-12	2700K		2 × 863lm		weiss / schwarz
59031-30-00	3000K		2 × 883lm		weiss matt
59031-30-12	3000K		2 × 883lm		weiss / schwarz

Zubehör

73142	Konverter dim [RC] 500mA 10-22W 127×44×28mm
730120-500	Konverter 20W Leuchten in Serie schalten!
59031-EB	Einbaugehäuse



Strom DC **500mA**
(Bitte passenden Konverter dazu bestellen)

Schutzart IP 20

Schutzklasse: III

LED V8

Leistung 2 × 9.2W

Farbwiedergabe Ra 90

Optik Reflektor 45° Schutzglas klar

Material Gehäuse Aluminium

Einbau Montage Rahmen randlos

Ausschnitt / Einbautiefe AS 204 × 114mm / ET 120

Massangaben 91 × 178 × 100mm

• Inklusive Montage Rahmen für den Deckeneinbau



59028 – 9.2W Einbaustrahler für Sichtbeton

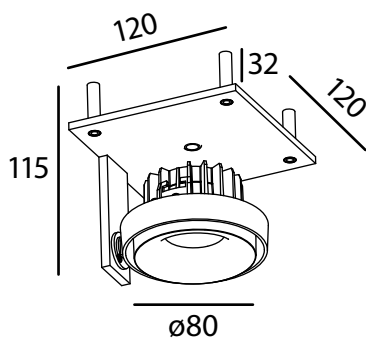

Spannung	220-240V AC, 50Hz (inkl. 500mA Konverter / dimmbar)
Schutzart	IP 20
Schutzklasse:	II
LED	bridgelux. V8
Leistung	9.2W
Farbwiedergabe Ra	90
Optik	Reflektor 45° Schutzglas klar
Kardanisch	45° / 30°
Material Gehäuse	Aluminium
Einbau	Direkt geschraubt
Ausschnitt / Einbautiefe	AS 125 × 125mm / ET 115mm
Massangaben	120 × 120 × 115mm



Phasenabschnitt dimmbar mit
Feller LED Universaldimmer
40200.LED

59028-27-75	2700K		863lm		silberfarbig
59028-30-75	3000K		883lm		silberfarbig

Zubehör

59028-EB	Einbaugehäuse AS 125 × 125mm
----------	------------------------------

59029 – 2 × 9.2W Einbaustrahler für Sichtbeton

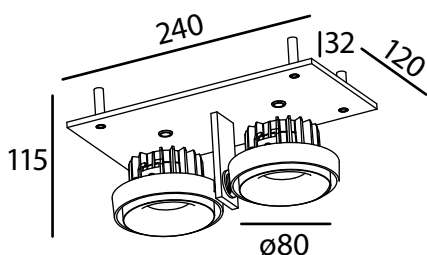

Spannung	220-240V AC, 50Hz (inkl. 500mA Konverter / dimmbar)
Schutzart	IP 20
Schutzklasse:	II
LED	bridgelux. V8
Leistung	2 × 9.2W
Farbwiedergabe Ra	90
Abstrahlwinkel	45°
Optik	Reflektor 45° Schutzglas klar
Kardanisch	45° / 30°
Material Gehäuse	Aluminium
Einbau	Direkt geschraubt
Ausschnitt / Einbautiefe	AS 125 × 245mm / ET 115mm
Massangaben	240 × 120 × 115mm



Phasenabschnitt dimmbar mit
Feller LED Universaldimmer
40200.LED

59029-27-75	2700K		2 × 863lm		silberfarbig
59029-30-75	3000K		2 × 883lm		silberfarbig

Zubehör

59029-EB	Einbaugehäuse AS 125 × 255mm
----------	------------------------------



59052 – 10W Line 5 Einbaustrahler



Strom DC	700mA (Bitte passenden Konverter dazu bestellen)
Schutzart	IP 20
Schutzklasse:	III
LED	OSLON Square
Leistung	5 × 2W
Farbwiedergabe Ra	80
Optik	Reflektor 48° Schutzglas klar
Material Gehäuse	Aluminium
Einbau	Spreizfedern
Ausschnitt / Einbautiefe	AS130 × 36mm / ET 75mm
Massangaben	137 × 44 × 52mm

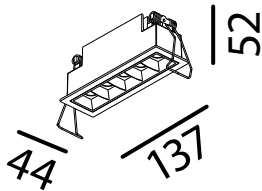

		Gehäuse	Reflektor
59052-30-12	3000K 1250lm	<input type="checkbox"/> weiss matt	<input checked="" type="checkbox"/> schwarz
59052-RF-00	Zusatz Reflektor	—	<input type="checkbox"/> weiss
59052-RF-03	Zusatz Reflektor	—	<input checked="" type="checkbox"/> gold

Zubehör

730060	Konverter 20W 150×52×28mm
59052-Eb	Einbaugehäuse AS 130×36mm

● Kein Lagerartikel

59053 – 20W Line 10 Einbaustrahler



Strom DC	700mA (Bitte passenden Konverter dazu bestellen)
Schutzart	IP 20
Schutzklasse:	III
LED	OSLON Square
Leistung	10 × 2W
Farbwiedergabe Ra	80
Optik	Reflektor 48° Schutzglas klar
Material Gehäuse	Aluminium
Einbau	Spreizfedern
Ausschnitt / Einbautiefe	AS 250 × 36mm / ET 75mm
Massangaben	257 × 44 × 52mm

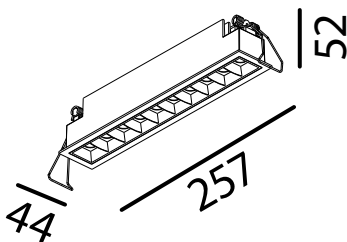

		Gehäuse	Reflektor
59053-30-12	3000K 2500lm	<input type="checkbox"/> weiss matt	<input checked="" type="checkbox"/> schwarz
59053-RF-00	Zusatz Reflektor	—	<input type="checkbox"/> weiss
59053-RF-03	Zusatz Reflektor	—	<input checked="" type="checkbox"/> gold

Zubehör

730060	Konverter 20W 150×52×28mm
59053-Eb	Einbaugehäuse AS 250×36mm

● Kein Lagerartikel



59040 – 10W Line 5 JS Einbaustrahler



Strom DC	700mA (Bitte passenden Konverter dazu bestellen)
Schutzart	IP 20
Schutzklasse:	III
LED	OSLON Square
Leistung	5 × 2W
Farbwiedergabe Ra	80
Optik	Reflektor 48° Schutzglas klar
Schwenkbar	45°
Material Gehäuse	Aluminium
Einbau	Spreizfedern
Ausschnitt / Einbautiefe	AS 144 × 76mm / ET 110mm
Massangaben	155 × 83 × 78mm

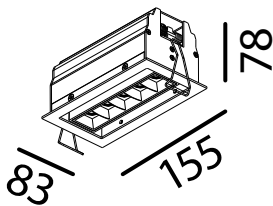

		Gehäuse	Reflektor
59040-30-12	3000K 1250lm	<input type="checkbox"/> weiss matt	<input checked="" type="checkbox"/> schwarz
59052-RF-00	Zusatz Reflektor	—	<input type="checkbox"/> weiss
59052-RF-03	Zusatz Reflektor	—	<input checked="" type="checkbox"/> gold

Zubehör

730060	Konverter 20W 150×52×28mm
59040-Eb	Einbaugehäuse AS 143×76mm

● Kein Lagerartikel

59041 – 20W Line 10 JS Einbaustrahler



Strom DC	700mA (Bitte passenden Konverter dazu bestellen)
Schutzart	IP 20
Schutzklasse:	III
LED	OSLON Square
Leistung	10 × 2W
Farbwiedergabe Ra	80
Optik	Reflektor 48° Schutzglas klar
Schwenkbar	45°
Material Gehäuse	Aluminium
Einbau	Spreizfedern
Ausschnitt / Einbautiefe	AS 265 × 76mm / ET 110mm
Massangaben	275 × 83 × 78mm

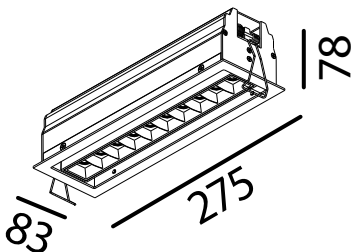

		Gehäuse	Reflektor
59041-30-12	3000K 2500lm	<input type="checkbox"/> weiss matt	<input checked="" type="checkbox"/> schwarz
59053-RF-00	Zusatz Reflektor	—	<input type="checkbox"/> weiss
59053-RF-03	Zusatz Reflektor	—	<input checked="" type="checkbox"/> gold

Zubehör

730060	Konverter 20W 150×52×28mm
59041-EB	Einbaugehäuse AS 265×76mm

● Kein Lagerartikel

74042 – 20W Einbaustrahler LED IP44 inkl. Konverter



Strom DC	500mA (inkl. Konverter)
Schutzart	IP 44
Schutzklasse:	II
LED	CREE
Leistung	20W
Farbwiedergabe Ra	90
Optik	Reflektor 40° Schutzglas klar
Material Gehäuse	Alu Druckguss
Einbau	Spreizfedern
Ausschnitt / Einbautiefe	AS ø120mm / ET 95mm
Massangaben	ø136 × 75mm

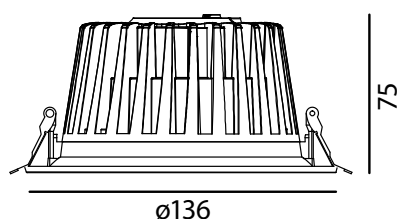

				Inkl. Konverter	
74042-30-00	3000K		1470lm	20W (on/off)	<input type="checkbox"/> weiss matt
74042-30-00DA	3000K		1470lm	DALI	<input type="checkbox"/> weiss matt

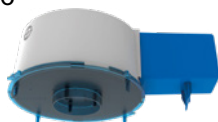

Zubehör	
205120	Einbaugehäuse mit Tank AS 120mm

74043 – 30W Einbaustrahler LED IP44 inkl. Konverter



Spannung	700mA (inkl. Konverter)
Schutzart	IP 44
Schutzklasse:	II
LED	CREE
Leistung	22W (500mA) / 30W (700mA)
Farbwiedergabe Ra	90
Optik	Reflektor 40° Schutzglas klar
Material Gehäuse	Alu Druckguss
Einbau	Spreizfedern
Ausschnitt / Einbautiefe	AS ø155mm / ET 120mm
Massangaben	ø176 × 100mm

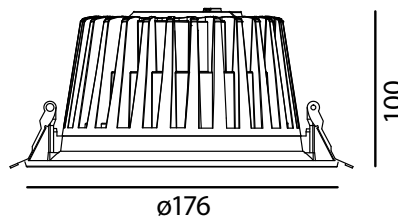

				Inkl. Konverter	
74043-30-00	3000K		2400lm	30W (on/off)	<input type="checkbox"/> weiss matt
74043-30-00DA	3000K		2400lm	DALI	<input type="checkbox"/> weiss matt

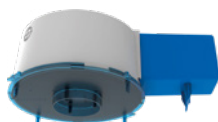

Zubehör	
205160	Einbaugehäuse mit Tank AS 160mm

74044 – 36W Einbaustrahler LED IP44 inkl. Konverter



Strom DC **900mA**
(inkl. Konverter)

Schutzart IP 44

Schutzklasse: II

LED **CREE**

Leistung 30W (700mA) / 36W (900mA)

Farbwiedergabe Ra 90

Optik Reflektor 40° Schutzglas klar

Material Gehäuse Alu Druckguss

Einbau Spreizfedern

Ausschnitt / Einbautiefe AS ø172mm / ET 125mm

Massangaben ø196 × 105mm

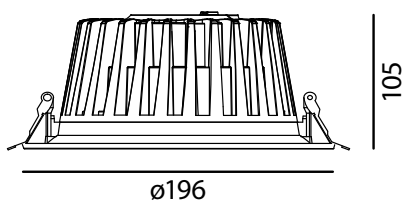

		Inkl. Konverter			
74044-30-00	3000K	2800lm	36W (on/off)	<input type="checkbox"/>	weiss matt
74044-30-00DA	3000K	2800lm	DALI	<input type="checkbox"/>	weiss matt
74044-40-00	4000K	3000lm	36W (on/off)	<input type="checkbox"/>	weiss matt
74044-40-00DA	4000K	3000lm	DALI	<input type="checkbox"/>	weiss matt

Zubehör

305175 Einbaugehäuse mit Tank AS 175mm

74046 – 50W Einbaustrahler LED IP44 inkl. Konverter



Strom DC **1200mA**
(inkl. Konverter)

Schutzart IP 44

Schutzklasse: II

LED **CREE**

Leistung 36W (900mA) / 50W (1200mA)

Farbwiedergabe Ra 90

Optik Reflektor 45° Schutzglas klar

Material Gehäuse Alu Druckguss

Einbau Spreizfedern

Ausschnitt / Einbautiefe AS ø210mm / ET 145mm

Massangaben ø230 × 125mm

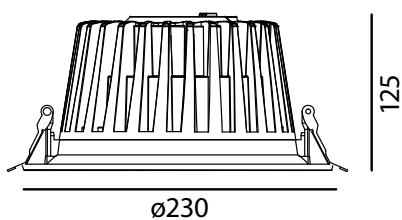

		Inkl. Konverter			
74046-30-00	3000K	3650lm	50W (on/off)	<input type="checkbox"/>	weiss matt
74046-30-00DA	3000K	3650lm	DALI	<input type="checkbox"/>	weiss matt
74046-40-00	4000K	4000lm	50W (on/off)	<input type="checkbox"/>	weiss matt
74046-40-00DA	4000K	4000lm	DALI	<input type="checkbox"/>	weiss matt

Zubehör

305210 Einbaugehäuse mit Tank AS 210mm



Möbeleinbauleuchten





53 74205

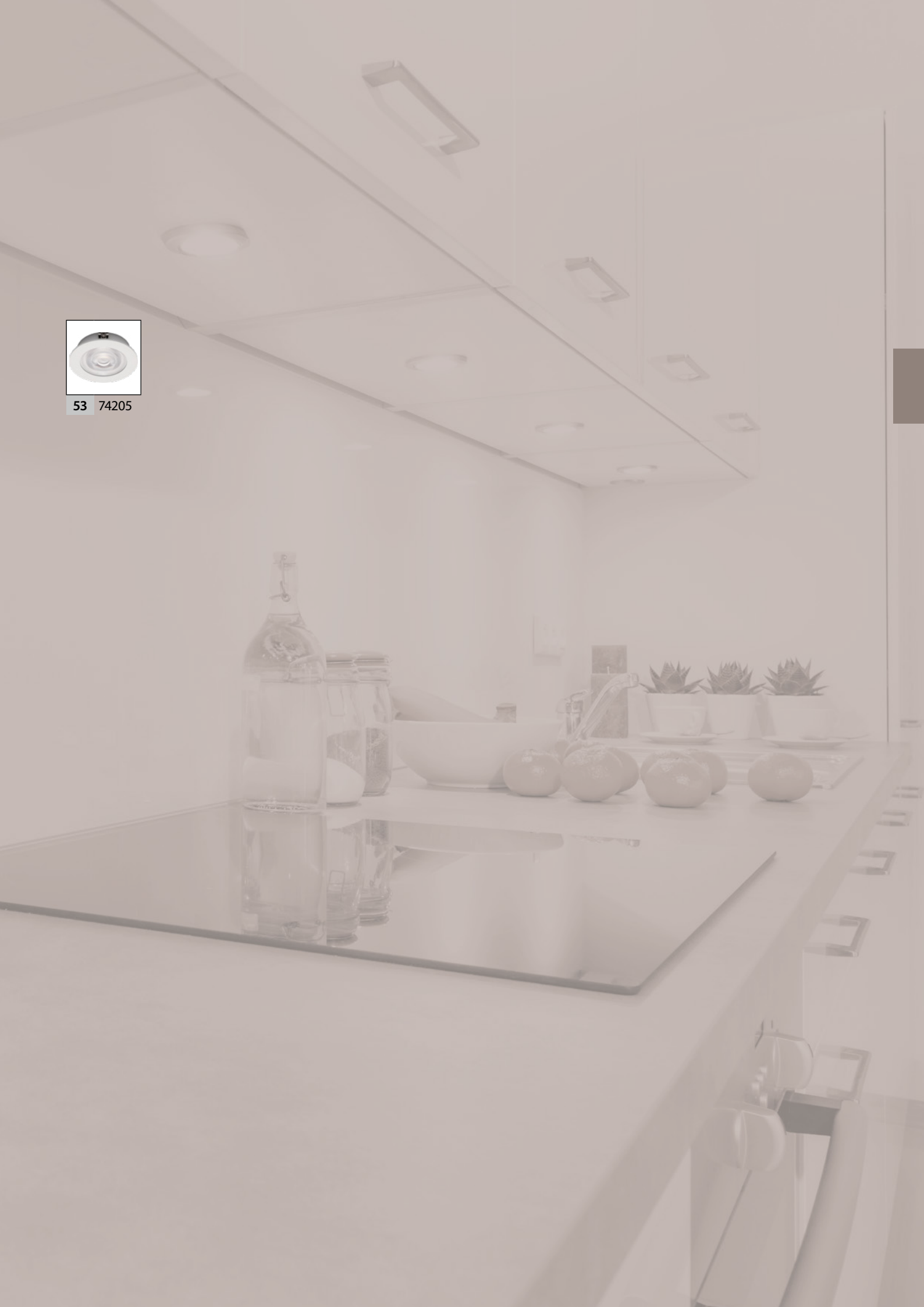



74205 – 3.2W Einbaustrahler



Strom DC **350 / 500mA**
(Bitte passenden Konverter dazu bestellen)

Schutzart IP 44

Schutzklasse: II

LED **bridgelux** V6

Leistung 3.2W / 4.6W

Farbwiedergabe Ra 90

Optik Linse 36°/60° (24° auf Anfrage)

Material Gehäuse Aluminium

Einbau Blattfedern

Ausschnitt / Einbautiefe AS ø58mm / ET 20

Massangaben ø68 × 18mm



ø 58



Zusammen mit Anbauring

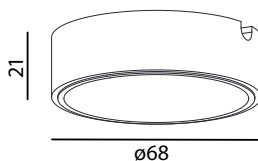
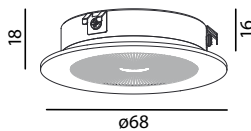

Abstrahlwinkel

74205-36-27-00	2700K		320lm		weiss matt	36°
74205-36-27-02	2700K		320lm		schwarz matt	36°
74205-36-27-05	2700K		320lm		nickel satin	36°
74205-36-27-75	2700K		320lm		silberfarbig	36°
74205-36-30-00	3000K		334lm		weiss matt	36°
74205-36-30-02	3000K		334lm		schwarz matt	36°
74205-36-30-05	3000K		334lm		nickel satin	36°
74205-36-30-75	3000K		334lm		silberfarbig	36°
74205-60-27-00	2700K		320lm		weiss matt	60°
74205-60-27-02	2700K		320lm		schwarz matt	60°
74205-60-27-05	2700K		320lm		nickel satin	60°
74205-60-27-75	2700K		320lm		silberfarbig	60°
74205-60-30-00	3000K		334lm		weiss matt	60°
74205-60-30-02	3000K		334lm		sschwarz matt	60°
74205-60-30-05	3000K		334lm		nickel satin	60°
74205-60-30-75	3000K		334lm		silberfarbig	60°

Anbauring

74209-00		weiss matt
74209-02		schwarz matt
74209-05		nickel satin
74209-75		silberfarbig

Zubehör

74214	Konverter mit 4-fach Verteiler 350mA 1-4 Leuchten
74215	Konverter mit 6-fach Verteiler 350mA 5-6 Leuchten
730060	Konverter 1-4 Leuchten 150×52×28mm
730091	Konverter 6-12 Leuchten 124×79×22mm
74210-01-00	1m Leuchtenkabel Verlängerung
74210-1.5-00	1.5m Leuchtenkabel Verlängerung
74210-02-00	2m Leuchtenkabel Verlängerung
74210-4-VT	4-fach Verteiler mit 1.5m Kabel
74210-6-VT	6-fach Verteiler mit 1.5m Kabel
	Überbrückungs Jumper für Mehrfach-Verteiler





Wandeinbauleuchten



New



57 E014

New

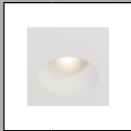

57 E016



59 5561



59 5563

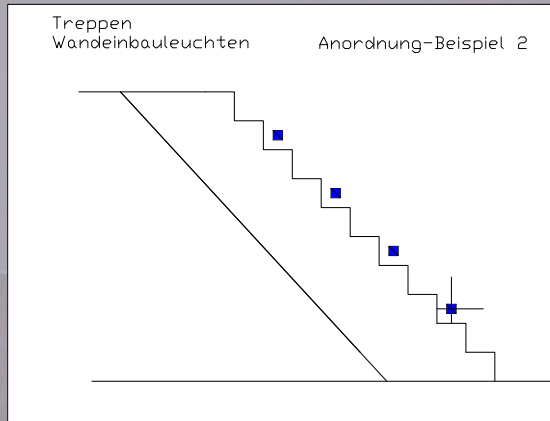
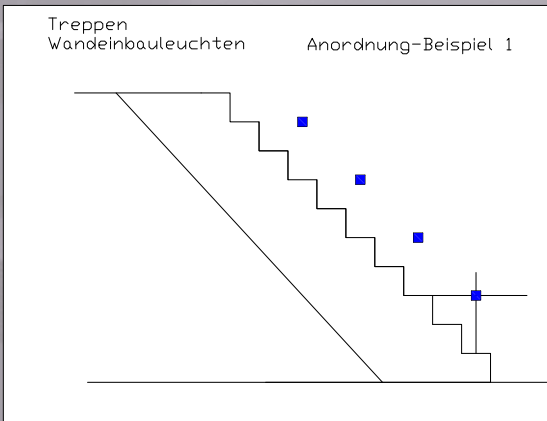



05-E014 – 2.2W Wandeinbaustrahler LED

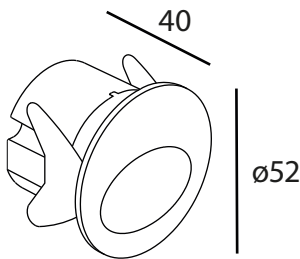

New	05-E014-14-CK	2700K		77lm	<input type="checkbox"/> weiss
New	05-E014-Z5-CK	2700K		77lm	<input checked="" type="checkbox"/> anthrazit
New	05-E014-14-CL	3000K		77lm	<input type="checkbox"/> weiss
New	05-E014-Z5-CL	3000K		77lm	<input checked="" type="checkbox"/> anthrazit

Zubehör

73154-700 Konverter | 700mA | 3W | 59×33×15mm

73005-06 **ON / OFF** Konverter | 700mA | 6W | 58×35×20mm

71-E065-60-00 Box für Wandeinbau



Strom DC **700mA**
(Bitte passenden Konverter dazu bestellen)

Schutzart IP 66

Schutzklasse: III

LED POWER LED

Leistung 2.2W

Farbwiedergabe Ra 92

Optik Schutzglas klar

Material Gehäuse Alu Druckguss

Einbau Blattfedern

Ausschnitt / Einbautiefe ø43mm / ET 50mm

Massangaben ø52 × 40mm

05-E016 – 2.2W Wandeinbaustrahler LED

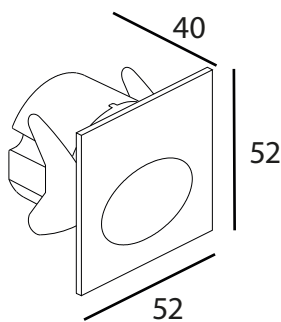
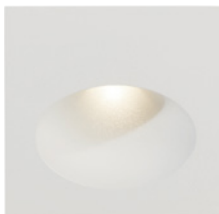

New	05-E016-14-CK	2700K		77lm	<input type="checkbox"/> weiss
New	05-E016-Z5-CK	2700K		77lm	<input checked="" type="checkbox"/> anthrazit
New	05-E016-14-CL	3000K		77lm	<input type="checkbox"/> weiss
New	05-E016-Z5-CL	3000K		77lm	<input checked="" type="checkbox"/> anthrazit

Zubehör

73154-700 Konverter | 700mA | 3W | 59×33×15mm

73005-06 **ON / OFF** Konverter | 700mA | 6W | 58×35×20mm

71-E065-60-00 Box für Wandeinbau



Strom DC **700mA**
(Bitte passenden Konverter dazu bestellen)

Schutzart IP 66

Schutzklasse: III

LED POWER LED

Leistung 2.2W

Farbwiedergabe Ra 92

Optik Schutzglas klar

Material Gehäuse Alu Druckguss

Einbau Blattfedern

Ausschnitt / Einbautiefe ø43mm / ET 50mm

Massangaben 52 × 52 × 40mm



5561 – 3W Wandeinbaustrahler LED

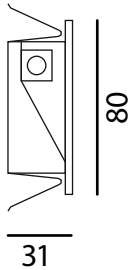

Strom DC **700mA**
(Bitte passenden Konverter dazu bestellen)

Schutzart IP 20

Schutzklasse: III

LED **CREE** ⇄

Leistung 3W

Farbwiedergabe Ra 80

Optik Schutzglas matt

Material Gehäuse Alu Druckguss

Einbau Blattfedern

Ausschnitt / Einbautiefe AS 68 × 68mm / ET 50mm

Massangaben 80 × 80 × 31mm

	5561-27-01	2700K		126lm	<input type="checkbox"/>	weiss matt
New	5561-27-02	2700K		126lm	<input checked="" type="checkbox"/>	schwarz matt
New	5561-27-13	2700K		126lm	<input checked="" type="checkbox"/>	alu eloxiert
	5561-30-01	3000K		140lm	<input type="checkbox"/>	weiss matt
New	5561-30-02	3000K		140lm	<input checked="" type="checkbox"/>	schwarz matt
New	5561-30-13	3000K		140lm	<input checked="" type="checkbox"/>	alu eloxiert

Zubehör

73007 Konverter | 700mA | 3.5W | 58×39×20mm

73154-700 Konverter | 700mA | 3W | 59×33×15mm

5565 Bx Box für Wandeinbau

5565 Pk Putzrahmen für Einbaubox

5563 – 4.2W Wandeinbaustrahler LED

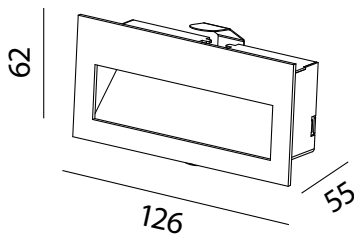

Strom DC **350mA**
(Bitte passenden Konverter dazu bestellen)

Schutzart IP 20

Schutzklasse: III

LED **CREE** ⇄

Leistung 4.2W

Farbwiedergabe Ra 90

Optik Schutzglas matt

Material Gehäuse Edelstahl

Einbau Blattfedern

Ausschnitt / Einbautiefe AS 112 × 50mm / ET 60mm

Massangaben 60 × 35 × 22mm

New	5563-27-01	2700K		432lm	<input type="checkbox"/>	weiss matt
New	5563-27-02	2700K		432lm	<input checked="" type="checkbox"/>	schwarz matt
New	5563-27-10	2700K		432lm	<input checked="" type="checkbox"/>	inox
New	5563-30-01	3000K		450lm	<input type="checkbox"/>	weiss matt
New	5563-30-02	3000K		450lm	<input checked="" type="checkbox"/>	schwarz matt
New	5563-30-10	3000K		450lm	<input checked="" type="checkbox"/>	inox

Zubehör

730004 Konverter | 350mA | 1-8W | 58×39×20mm

80779 Konverter | 350mA | 8W | ø58×28mm

5565 Bx Box für Wandeinbau

5565-4 Putzrahmen für Einbaubox



Halbeinbauleuchten



New



63 59060-10

Orb 10

New



63 59060-10

Orb 10



65 95028

Turn In



65 56040



67 59039

Tube



68 59035

Tube



69 59036

Tube



71 59038

Tube



73 59033

Tube





56060-10 – 7.8W Orb 10 Kugelleuchte mit Einbaumodul



Strom DC **200mA**
(Bitte passenden Konverter dazu bestellen)

Schutzart IP 20

Schutzklasse: III

LED *bridgelux* SMD 2835

Leistung 7.8W

Farbwiedergabe Ra 90

Optik Diffusor opal

Material Gehäuse Aluminium

Einbau Spreizfedern

Ausschnitt / Einbautiefe AS ø68mm / ET 45mm

Massangaben ø100 × 128mm

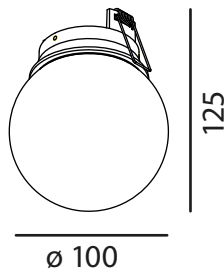

New 56060-10-27-00 **2700K** 897lm weiss matt

New 56060-10-30-00 **3000K** 975lm weiss matt

Zubehör

730115 Konverter | 8.2W | 103×37×25mm

56060-14 – 9.7W Orb 14 Kugelleuchte mit Einbaumodul



Strom DC **250mA**
(Bitte passenden Konverter dazu bestellen)

Schutzart IP 20

Schutzklasse: III

LED *bridgelux* SMD 2835

Leistung 9.7W

Farbwiedergabe Ra 90

Optik Diffusor opal

Material Gehäuse Aluminium

Einbau Spreizfedern

Ausschnitt / Einbautiefe AS ø68mm / ET 45mm

Massangaben ø135 × 168mm

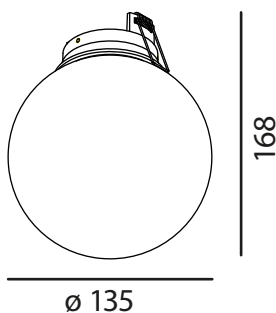

New 56060-14-27-00 **2700K** 1070lm weiss matt

New 56060-14-30-00 **3000K** 1150lm weiss matt

Zubehör

730115 Konverter | 10.5W | 103×37×25mm



95028 – 9.2W / 13.6W Turn In Halbeinbaustrahler

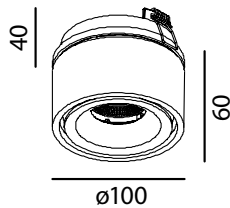

ø100

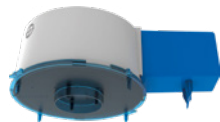

	500mA	700mA		
95028-27-00	2700K	863lm	1115lm	weiss matt
95028-27-12	2700K	863lm	1115lm	weiss matt / schwarz
95028-30-00	3000K	883lm	1141lm	weiss matt
95028-30-12	3000K	883lm	1141lm	weiss matt / schwarz

Zubehör

730051-12U	Konverter dim [RC] 500mA 6-12W 115×40×22mm
730120-500	Konverter 29W 145×46×31mm
205090	Einbaugehäuse mit Tank AS ø90mm



Spannung	500 / 700mA (Bitte passenden Konverter dazu bestellen)
Schutzart	IP 20
Schutzklasse:	III

LED V8

Leistung	9.2 / 13.6W
Farbwiedergabe Ra	90
Optik	Reflektor 45°
Dreh- und schwenkbar	355° / 90°
Material Gehäuse	Aluminium
Einbau	Spreizfedern
Ausschnitt / Einbautiefe	AS ø90mm / ET 40mm
Massangaben	ø100 × 103mm

56040 – 9.2W Halbeinbaustrahler

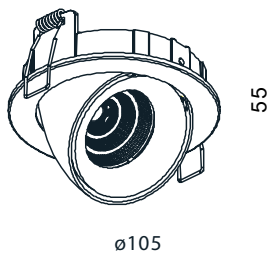

ø105

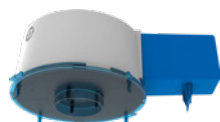

56040-27-00	2700K	863lm	weiss matt
56040-27-02	2700K	863lm	schwarz matt
56040-27-75	2700K	863lm	silberfarbig
56040-30-00	3000K	883lm	weiss matt
56040-30-02	3000K	883lm	schwarz matt
56040-30-75	3000K	883lm	silberfarbig

Zubehör

730051-12U	Konverter dim [RC] 500mA 6-12W 115×40×22mm
730115-500	Konverter 10W 103×37×25mm
205095	Einbaugehäuse mit Tank AS ø95mm



Strom DC	500mA (Bitte passenden Konverter dazu bestellen)
Schutzart	IP 20
Schutzklasse:	III

LED V8

Leistung	9.2W
Farbwiedergabe Ra	90
Optik	Reflektor 45° Schutzglas klar
Dreh- und schwenkbar	355° / 45°
Material Gehäuse	Aluminium
Einbau	Spreizfedern
Ausschnitt / Einbautiefe	AS ø95mm / ET 70mm
Massangaben	ø105 × 55mm



59039 – 12.2W Tube Anbaustrahler mit Einbaumodul



Strom DC **350mA**
(Bitte passenden Konverter dazu bestellen)

Schutzart IP 20

Schutzklasse: III

LED **bridgelux** V10c

Leistung 12.2W

Farbwiedergabe Ra 90

Optik Reflektor 48° Schutzglas klar

Dreh- und schwenkbar 355° / 90°

Material Gehäuse Aluminium

Einbau Spreizfedern

Ausschnitt / Einbautiefe AS ø60–68mm / ET 30mm

Massangaben ø80 × 90mm



ø 60–68

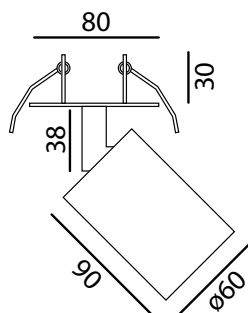

2700K 1456lm **3000K** 1525lm

59039-27-00 59039-30-00 weiss matt

59039-27-02 59039-30-02 schwarz matt

59039-27-75 59039-30-75 silberfarbig

Zubehör

730008-NT Konverter dim [RC] | 350mA | 9-18W | 120×45×28mm

730125-DT6 Konverter | 20W | 120×41×28mm

Filter

95055-SF60 Soft Filter

95055-SL60 Prisma Filter

95055-WB60 Waben Filter

Reflektoren

95055-RF60-30 transparent

95055-RF60-03 gold

95055-RF60-02 schwarz



59035 – 9.2W Tube Halbeinbaustrahler



Strom DC	500mA (Bitte passenden Konverter dazu bestellen)
Schutzart	IP 20
Schutzklasse:	III
LED	bridgelux V8
Leistung	9.2W
Farbwiedergabe Ra	90
Optik	Reflektor 48° Schutzglas klar
Dreh- und schwenkbar	355° / 90°
Material Gehäuse	Aluminium
Einbau	Spreizfedern
Ausschnitt / Einbautiefe	AS ø90mm / ET 120mm
Massangaben	ø106 × 117mm

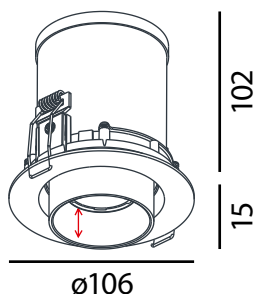

2700K 863lm	3000K 883lm	
59035-27-00	59035-30-00	weiss matt
59035-27-12	59035-30-12	weiss matt / schwarz
59035-27-02	59035-30-02	schwarz matt
59035-27-23	59035-30-23	schwarz / gold
59035-27-75	59035-30-75	silberfarbig

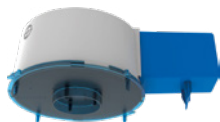

Zubehör	
730051-12U	Konverter dim [RC] 500mA 6-12W 115×40×22mm
730115-500	Konverter 10W 103×37×25mm
205090	Einbaugehäuse AS ø90mm



Filter	
95055-SF60	Soft Filter
95055-SL60	Prisma Filter
95055-WB60	Waben Filter



Reflektoren	
95055-RF60-30	transparent
95055-RF60-03	gold
95055-RF60-02	schwarz

59036 – 9.2W Tube Halbeinbaustrahler randlos

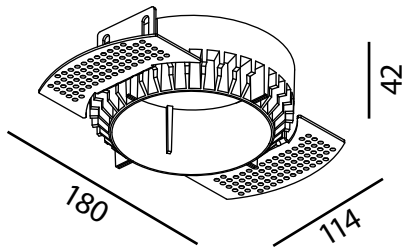

Inklusive Montagerahmen

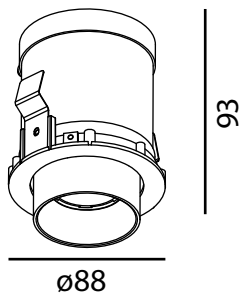

Strom DC **500mA**
(Bitte passenden Konverter dazu bestellen)

Schutzart IP 20

Schutzklasse: III

LED **bridgelux** V8

Leistung 9.2W

Farbwiedergabe Ra 90

Optik Reflektor 48° Schutzglas klar

Dreh- und schwenkbar 355° / 90°

Material Gehäuse Aluminium

Einbau Montageplatte

Ausschnitt / Einbautiefe AS ø120mm / ET 120mm

Massangaben ø88 × 93mm

59036-27-00

2700K



863lm



weiss matt

59036-30-00

3000K



883lm



weiss matt

Zubehör

730051-12U

Konverter dim [RC] | 500mA | 6-12W | 115×40×22mm

730115-500

Konverter | 10W | 103×37×25mm

59036-EB

Einbaugehäuse AS ø120mm

Filter

95055-SF60

Soft Filter

95055-SL60

Prisma Filter

95055-WB60

Waben Filter

Reflektoren

95055-RF60-30

transparent

95055-RF60-03

gold

95055-RF60-02

schwarz



Alle Preise excl. MwSt. und VRG.



59038 – 2 × 9.2W Tube Halbeinbaustrahler

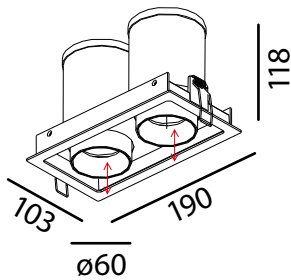

Strom DC **500mA**
(Bitte passenden Konverter dazu bestellen)

Schutzart IP 20

Schutzklasse: III

LED **bridgelux** V8

Leistung 2 × 9.2W

Farbwiedergabe Ra 90

Optik Reflektor 48° Schutzglas klar

Dreh- und schwenkbar 355° / 90°

Material Gehäuse Aluminium

Einbau Spreizfedern

Ausschnitt / Einbautiefe AS 180 × 93mm / ET 125mm

Massangaben 190 × 103 × 118mm



59038-27-00	2700K		2 × 863lm		weiss matt
59038-27-12	2700K		2 × 863lm		weiss matt / schwarz
59038-30-00	3000K		2 × 883lm		weiss matt
59038-30-12	3000K		2 × 883lm		weiss matt / schwarz

Zubehör

73142	Konverter dim [RC] 500mA 10-22W 127×44×28mm
730120-500	Konverter 29W Leuchten in Serie schalten!
310400-180	Einbetonierdose mit Ausschnitt 180 × 93 für 59038
300001	Benötigt 2× Zwischenring 15mm

Filter

95055-SF60	Soft Filter
95055-SL60	Prisma Filter
95055-WB60	Waben Filter

Reflektoren

95055-RF60-30	transparent
95055-RF60-03	gold
95055-RF60-02	schwarz





59033 – 2 x 9.2W Tube Halbeinbaustrahler randlos

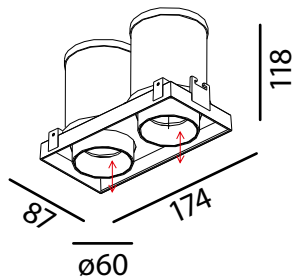
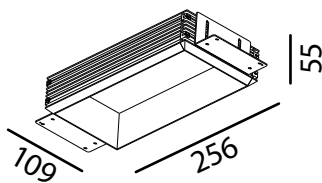

Strom DC **500mA**
(Bitte passenden Konverter dazu bestellen)

Schutzart IP 20

Schutzklasse: III

LED **bridgelux** V8

Leistung 2 x 9.2W

Farbwiedergabe Ra 90

Optik Reflektor 48° Schutzglas klar

Dreh- und schwenkbar 355° / 90°

Material Gehäuse Aluminium

Einbau Montageplatte

Ausschnitt / Einbautiefe AS 198 x 112mm / ET140mm

Massangaben 174 x 87 x 118mm



198 x 112

59033-27-00	2700K		2 x 863lm		weiss matt
59033-27-12	2700K		2 x 863lm		weiss matt / schwarz
59033-30-00	3000K		2 x 883lm		weiss matt
59033-30-12	3000K		2 x 883lm		weiss matt / schwarz

Zubehör

73142	Konverter dim [RC] 500mA 10-22W 127x44x28mm
730120-500	Konverter 29W Leuchten in Serie schalten!
59033-EB	Einbaugeschäse AS 198 x 112mm

Filter

95055-SF60	Soft Filter
95055-SL60	Prisma Filter
95055-WB60	Waben Filter

Reflektoren

95055-RF60-30	transparent
95055-RF60-03	gold
95055-RF60-02	schwarz



Alle Preise excl. MwSt. und VRG.



Anbaustrahler



77 95059

Cily



77 95050

Quby



78 95032

Tube

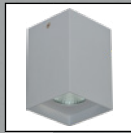

78 95051

Cubbo



79 63005

Tube Outdoor



79 63006

Quby Outdoor

New



80 65035

Lente R



80 65036

Lente Q



81 95033

Lupe



82 95053

Quadrato



82 95054

Rettangola



83 95052

Cilindro

New



85 65038

Bovy



86 95035

Linso



87 95036

Linso



89 95027

Turn out



89 95026

Turn out DALI



91 95040

Mini Tube



93 95042

Mini Tube Line 2

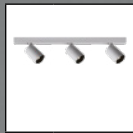

95 95043

Mini Tube Line 3



97 95041

Mini Tube Duo



99 95045

Mini Tube Trio

New



100 63120

Moon 16



101 63121

Moon+ 26



101 63122

Moon+ 35



95059 – 8.9W Cily LED Anbaustrahler

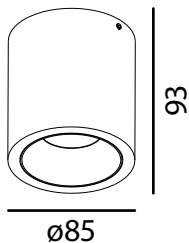

Spannung 220-240V AC, 50Hz
(inkl. 500mA Konverter / dimmbar)

Schutzart IP 20

Schutzklasse: I

LED *bridgelux* V8

Leistung 8.9W

Farbwiedergabe Ra 90

Optik Reflektor 33° Schutzglas klar

Material Gehäuse Aluminium

Anbau Direkt geschraubt

Massangaben ø85 × 93mm



Phasenabschnitt dimmbar mit
Feller LED Universaldimmer
40200.LED

95059-27-00	2700K		863lm		weiss matt
95059-27-02	2700K		863lm		schwarz matt
95059-27-23	2700K		863lm		schwarz gold
95059-27-75	2700K		863lm		silberfarbig
95059-30-00	3000K		883lm		weiss matt
95059-30-02	3000K		883lm		schwarz matt
95059-30-23	3000K		883lm		schwarz gold
95059-30-75	3000K		883lm		silberfarbig

95050 – 9.2W Quby LED Anbaustrahler

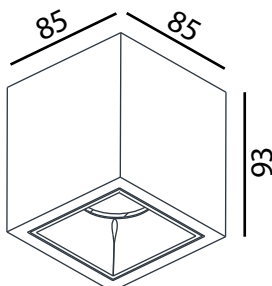

Spannung 220-240V AC, 50Hz
(inkl. 500mA Konverter / dimmbar)

Schutzart IP 20

Schutzklasse: I

LED *bridgelux* V8

Leistung 9.2W

Farbwiedergabe Ra 90

Optik Reflektor 33° Schutzglas klar

Material Gehäuse Aluminium

Anbau Direkt geschraubt

Massangaben 85 × 85 × 93mm



Phasenabschnitt dimmbar mit
Feller LED Universaldimmer
40200.LED

95050-27-00	2700K		863lm		weiss matt
95050-27-23	2700K		863lm		schwarz gold
95050-27-75	2700K		863lm		silberfarbig
95050-27-85	2700K		863lm		dunkelgrau
95050-30-00	3000K		883lm		weiss matt
95050-30-75	3000K		883lm		silberfarbig
95050-30-85	3000K		883lm		dunkelgrau

95032 – 9.3W Tube LED Anbaustrahler

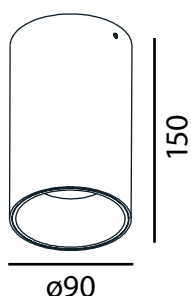

Spannung	220-240V AC, 50Hz (inkl. 350mA Konverter / dimmbar)
Schutzart	IP 20
Schutzklasse:	I
LED	bridgelux V10
Leistung	9.3W
Farbwiedergabe Ra	90
Optik	Reflektor 50° Schutzglas klar
Material Gehäuse	Aluminium
Anbau	Montagplatte
Massangaben	ø90 × 150mm



Phasenabschnitt dimmbar mit
Feller LED Universaldimmer
40200.LED

95032-27-00	2700K	AG E	956lm	weiss matt
95032-27-02	2700K	AG E	956lm	schwarz matt
95032-27-75	2700K	AG E	956lm	silberfarbig
95032-30-00	3000K	AG E	1003lm	weiss matt
95032-30-02	3000K	AG E	1003lm	schwarz matt
95032-30-75	3000K	AG E	1003lm	silberfarbig

95051 – 9.3W Cubbo LED Anbaustrahler

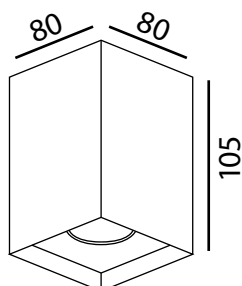

Spannung	220-240V AC, 50Hz (inkl. 350mA Konverter / dimmbar)
Schutzart	IP 20
Schutzklasse:	I
LED	bridgelux V10
Leistung	9.3W
Farbwiedergabe Ra	90
Optik	Reflektor 35° (12° / 24° auf Anfrage) Schutzglas klar
Material Gehäuse	Aluminium
Anbau	Montagebügel
Massangaben	80 × 80 × 105mm



Phasenabschnitt dimmbar mit
Feller LED Universaldimmer
40200.LED

95051-27-00	2700K	AG E	956lm	weiss matt
95051-27-02	2700K	AG E	956lm	schwarz matt
95051-27-75	2700K	AG E	956lm	silberfarbig
95051-30-00	3000K	AG E	1003lm	weiss matt
95051-30-02	3000K	AG E	1003lm	schwarz matt
95051-30-75	3000K	AG E	1003lm	silberfarbig

63005 – 9.2W Tube Outdoor LED Anbaustrahler IP65

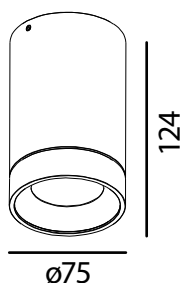

Spannung	220-240V AC, 50Hz (inkl. 500mA Konverter / dimmbar)
Schutzart	IP 65
Schutzklasse:	I
LED	bridgelux V8
Leistung	9.2W
Farbwiedergabe Ra	90
Optik	Reflektor 36° Schutzglas klar
Material Gehäuse	Aluminium
Anbau	Montageplatte
Massangaben	ø75 × 124mm



Phasenabschnitt dimmbar mit
Feller LED Universaldimmer
40200.LED

63005-27-00	2700K		863lm		weiss matt
63005-27-02	2700K		863lm		schwarz matt
63005-27-75	2700K		863lm		silberfarbig
63005-30-00	3000K		883lm		weiss matt
63005-30-02	3000K		883lm		schwarz matt
63005-30-75	3000K		883lm		silberfarbig

63006 – 9.2W Quby Outdoor LED Anbaustrahler IP65

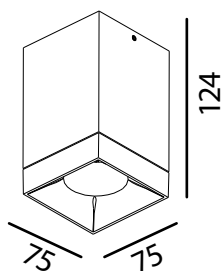

Spannung	220-240V AC, 50Hz (inkl. 500mA Konverter / dimmbar)
Schutzart	IP 65
Schutzklasse:	I
LED	bridgelux V8
Leistung	9.2W
Farbwiedergabe Ra	90
Optik	Reflektor 36° Schutzglas klar
Material Gehäuse	Aluminium
Anbau	Montageplatte
Massangaben	75 × 75 × 124mm



Phasenabschnitt dimmbar mit
Feller LED Universaldimmer
40200.LED

63006-27-00	2700K		863lm		weiss matt
63006-27-02	2700K		863lm		schwarz matt
63006-27-75	2700K		863lm		silberfarbig
63006-30-00	3000K		883lm		weiss matt
63006-30-02	3000K		883lm		schwarz matt
63006-30-75	3000K		883lm		silberfarbig

65035 – 8.7W Lente R Aufbaustrahler IP54

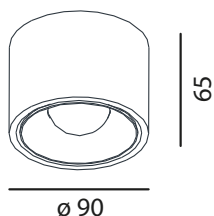

Phasenabschnitt dimmbar mit
Feller LED Universaldimmer
40200.LED

New	65035-27-00	2700K	A B E	1000lm	weiss matt
New	65035-27-02	2700K	A B E	1000lm	schwarz matt
New	65035-30-00	3000K	A B E	1046lm	weiss matt
New	65035-30-02	3000K	A B E	1046lm	schwarz matt



Spannung	220-240V AC, 50Hz (inkl. 500mA Konverter / dimmbar)
Schutzart	IP 54
Schutzklasse:	I
LED	bridgelux. V8
Leistung	8.7W
Farbwiedergabe Ra	90
Optik	Linse 34°
Material Gehäuse	Aluminium
Einbau	Direkt geschraubt
Massangaben	ø90 × 65mm

65036 – 8.7W Lente Q Aufbaustrahler IP54

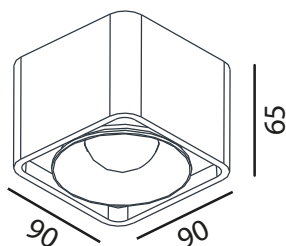

Phasenabschnitt dimmbar mit
Feller LED Universaldimmer
40200.LED

New	65036-27-00	2700K	A B E	1000lm	weiss matt
New	65036-27-02	2700K	A B E	1000lm	schwarz matt
New	65036-30-00	3000K	A B E	1046lm	weiss matt
New	65036-30-02	3000K	A B E	1046lm	schwarz matt



Spannung	220-240V AC, 50Hz (inkl. 500mA Konverter / dimmbar)
Schutzart	IP 54
Schutzklasse:	I
LED	bridgelux. V8
Leistung	8.7W
Farbwiedergabe Ra	90
Optik	Linse 34°
Material Gehäuse	Aluminium
Einbau	Direkt geschraubt
Massangaben	90 × 90 × 65mm

95033 – 9.2W Lupe Aufbaustrahler IP54

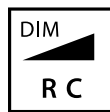
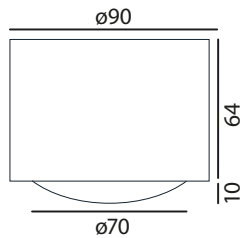

Phasenabschnitt dimmbar mit
Feller LED Universaldimmer
40200.LED



Spannung	220-240V AC, 50Hz (inkl. 500mA Konverter / dimmbar)
Schutzart	IP 54
Schutzklasse:	I
LED	bridgelux V8
Leistung	9.2W
Farbwiedergabe Ra	90
Optik	Linse 32°
Material Gehäuse	Aluminium
Einbau	Direkt geschraubt
Massangaben	ø90 × 74mm

New	95033-27-00	2700K		863lm		weiss matt
New	95033-27-02	2700K		863lm		schwarz matt
New	95033-30-00	3000K		883lm		weiss matt
New	95033-30-02	3000K		883lm		schwarz matt

95053 – 12W Quadrato LED Anbaustrahler



Spannung	220-240V AC, 50Hz (inkl. 350mA Konverter / dimmbar)
Schutzart	IP 20
Schutzklasse:	LED CITIZEN CLU028
Leistung	11.4W
Farbwiedergabe Ra	90
Optik	Linse
Material Gehäuse	Alu-Druckguss
Massangaben	93 × 93 × 93mm



Phasenabschnitt dimmbar mit
Feller LED Universaldimmer
40200.LED

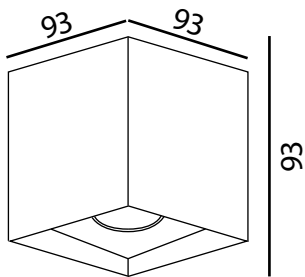

95053-27-00	2700K	A F	1139lm		weiss matt
95053-27-02	2700K	A F	1139lm		schwarz matt
95053-27-23	2700K	A F	1139lm		schwarz gold
95053-27-75	2700K	A F	1139lm		silberfarbig
95053-30-00	3000K	A E	1266lm		weiss matt
95053-30-02	3000K	A E	1266lm		schwarz matt
95053-30-23	3000K	A E	1266lm		schwarz gold
95053-30-75	3000K	A E	1266lm		silberfarbig

95054 – 2 × 12W Rettangolo LED Anbaustrahler



Spannung	220-240V AC, 50Hz (inkl. 350mA Konverter / dimmbar)
Schutzart	IP 20
Schutzklasse:	LED CITIZEN CLU028
Leistung	2 × 11.4W
Farbwiedergabe Ra	90
Optik	Linse
Material Gehäuse	Alu-Druckguss
Massangaben	93 × 93 × 186mm



Phasenabschnitt dimmbar mit
Feller LED Universaldimmer
40200.LED

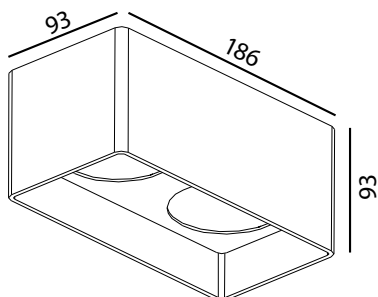

95054-27-00	2700K	A F	2 × 1139lm		weiss matt
95054-27-02	2700K	A F	2 × 1139lm		schwarz matt
95054-27-23	2700K	A F	2 × 1139lm		schwarz gold
95054-27-75	2700K	A F	2 × 1139lm		silberfarbig
95054-30-00	3000K	A E	2 × 1266lm		weiss matt
95054-30-02	3000K	A E	2 × 1266lm		schwarz matt
95054-30-23	3000K	A E	2 × 1266lm		schwarz gold
95054-30-75	3000K	A E	2 × 1266lm		silberfarbig

95052 – 12W Cilindro LED Anbaustrahler



Spannung	220-240V AC, 50Hz (inkl. 300mA Konverter / dimmbar)
Schutzart	IP 20
Schutzklasse:	I
LED	CITIZEN CLU028
Leistung	11.4W
Farbwiedergabe Ra	90
Optik	Linse 36°
Material Gehäuse	Alu-Druckguss
Massangaben	ø93 × 93mm



Phasenabschnitt dimmbar mit
Feller LED Universaldimmer
40200.LED

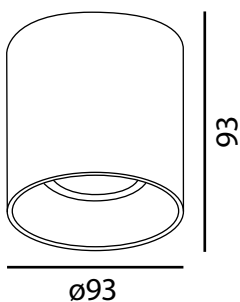

95052-27-00	2700K		1139lm		weiss matt
95052-27-02	2700K		1139lm		schwarz matt
95052-27-23	2700K		1139lm		schwarz gold
95052-27-18	2700K		1139lm		champagner
95052-27-28	2700K		1139lm		rosegold
95052-30-00	3000K		1266lm		weiss matt
95052-30-02	3000K		1266lm		schwarz matt
95052-30-23	3000K		1266lm		schwarz gold
95052-30-75	3000K		1266lm		silberfarbig





65038 – 12.2W Bovy LED Anbaustrahler

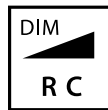
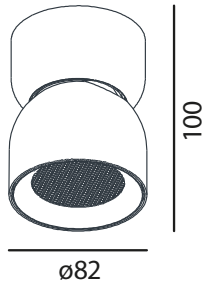

Phasenabschnitt dimmbar mit
Feller LED Universaldimmer
40200.LED

New	65038-27-00	2700K	A B E	1321lm	<input type="checkbox"/> weiss matt
New	65038-27-02	2700K	A B E	1321lm	<input type="checkbox"/> schwarz matt
New	65038-30-00	3000K	A B E	1370lm	<input type="checkbox"/> weiss matt
New	65038-30-02	3000K	A B E	1370lm	<input type="checkbox"/> schwarz matt

Dekorativer Ring

65038-RF-03 gold



Spannung 220-240V AC, 50Hz
(inkl. 350mA Konverter / dimmbar)

Schutzart IP 20

Schutzklasse: I

LED V10c

Leistung 12.2W

Farbwiedergabe Ra 90

Optik Reflektor 50°

Dreh- und schwenkbar 355° / 75°

Material Gehäuse Aluminium

Aufbau Montageplatte

Massangaben ø82 × 100mm

Inklusive Wabenfilter

65038 DA – 12.2W Bovy LED AnbaustrahlerKonverter

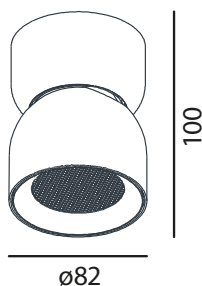

New	65038-27-00 DA	2700K	A B E	1321lm	<input type="checkbox"/> weiss matt
New	65038-27-02 DA	2700K	A B E	1321lm	<input type="checkbox"/> schwarz matt
New	65038-30-00 DA	3000K	A B E	1370lm	<input type="checkbox"/> weiss matt
New	65038-30-02 DA	3000K	A B E	1370lm	<input type="checkbox"/> schwarz matt

Dekorativer Ring

65038-RF-03 gold



Spannung 220-240V AC, 50Hz
(inkl. 350mA Konverter / DALI dimmbar)

Schutzart IP 20

Schutzklasse: I

LED V10c

Leistung 12.2W

Farbwiedergabe Ra 90

Optik Reflektor 50°

Dreh- und schwenkbar 355° / 75°

Material Gehäuse Aluminium

Aufbau Montageplatte

Massangaben ø82 × 100mm

Inklusive Wabenfilter

95035 – 12.2W Linso LED Anbaustrahler



Spannung	220-240V AC, 50Hz (inkl. 350mA Konverter / dimmbar)
Schutzart	IP 20
Schutzklasse:	I
LED	bridgelux V10c
Leistung	12.2W
Farbwiedergabe Ra	90
Optik	Reflektor 48°
Dreh- und schwenkbar	355° / 90°
Material Gehäuse	Aluminium
Aufbau	Montageplatte
Massangaben	ø120 × 82mm

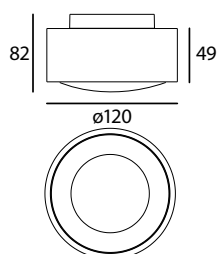

95035-27-00	2700K	A E	1462lm	<input type="checkbox"/> weiss matt
95035-27-02	2700K	A E	1462lm	<input checked="" type="checkbox"/> schwarz matt
95035-30-00	3000K	A D	1531lm	<input type="checkbox"/> weiss matt
95035-30-02	3000K	A D	1531lm	<input checked="" type="checkbox"/> schwarz matt

Reflektoren	
95035-RF22	22° Reflektor für Lens Anbaustrahler
95035-RF36	36° Reflektor für Lens Anbaustrahler

95035 – 11.8W Linso DTW LED Anbaustrahler



Spannung	220-240V AC, 50Hz (inkl. 350mA Konverter / dimmbar)
Schutzart	IP 20
Schutzklasse:	I
LED	bridgelux V10c
Leistung	11.8W
Farbwiedergabe Ra	90
Optik	Reflektor 48°
Dreh- und schwenkbar	355° / 90°
Material Gehäuse	Aluminium
Aufbau	Montageplatte
Massangaben	ø120 × 82mm

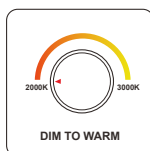

Dim to Warm Funktion nur mit einem PhasenAbschnitt Dimmer möglich, z.B. Feller LED Universaldimmer 40200.LED

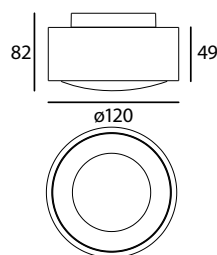

95035-50-00	1800–3000K	A F	1037lm	<input type="checkbox"/> weiss matt
95035-50-02	1800–3000K	A F	1037lm	<input checked="" type="checkbox"/> schwarz matt

Reflektoren	
95035-RF28	28° Reflektor für Lens DTW Anbaustrahler
95035-RF38	38° Reflektor für Lens DTW Anbaustrahler

95036 – 2 × 12.2W Linso LED Anbaustrahler



Spannung 220-240V AC, 50Hz
(inkl. 350mA Konverter / dimmbar)

Schutzart IP 20

Schutzklasse: I

LED **bridgelux** V10c

Leistung 2 × 12.2W

Farbwiedergabe Ra 90

Optik Reflektor 48°

Dreh- und schwenkbar 355° / 90°

Material Gehäuse Aluminium

Aufbau Montageplatte

Massangaben ø120 × 82mm

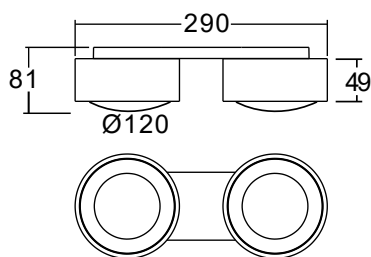

95036-27-00

2700K



2 × 1462lm weiss matt

95036-27-02

2700K



2 × 1462lm schwarz matt

95036-30-00

3000K



2 × 1531lm weiss matt

95036-30-02

3000K



2 × 1531lm schwarz matt

Reflektoren

95036-RF22 22° Reflektor für **Linso** Anbaustrahler

95036-RF36 36° Reflektor für **Linso** Anbaustrahler

95036 – 2 × 11.8W Linso DTW LED Anbaustrahler



Spannung 220-240V AC, 50Hz
(inkl. 350mA Konverter / dimmbar)

Schutzart IP 20

Schutzklasse: I

LED **bridgelux** V10c

Leistung 2 × 11.8W

Farbwiedergabe Ra 90

Optik Reflektor 48°

Dreh- und schwenkbar 355° / 90°

Material Gehäuse Aluminium

Aufbau Montageplatte

Massangaben ø120 × 82mm

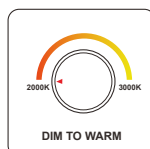

Dim to Warm Funktion nur mit einem
Phasenabschnitt Dimmer möglich, z.B.
Feller LED Universaldimmer 40200.LED

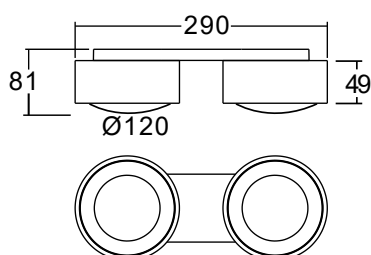

95036-50-00

1800-3000K



2 × 1037lm weiss matt

95036-50-02

1800-3000K



2 × 1037lm schwarz matt

Reflektoren

95036-RF28 28° Reflektor für **Lens DTW** Anbaustrahler

95036-RF38 38° Reflektor für **Lens DTW** Anbaustrahler



95027 – 9.3W Turn out LED Anbaustrahler

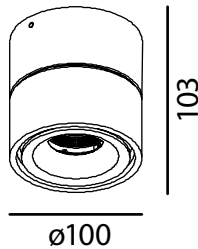
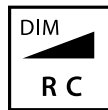

Spannung	220-240V AC, 50Hz (inkl. 500mA Konverter / dimmbar)
Schutzart	IP 20
Schutzklasse:	I
LED	bridgelux. V8
Leistung	9.3W
Farbwiedergabe Ra	80
Optik	Reflektor 45°
Dreh- und schwenkbar	35° / 90°
Material Gehäuse	Aluminium
Aufbau	Montageplatte
Massangaben	ø100 × 103mm

95027-27-00	2700K	AG F	835lm		weiss matt
95027-27-12	2700K	AG F	835lm		weiss / schwarz
95027-27-02	2700K	AG F	835lm		schwarz matt
95027-27-23	2700K	AG F	835lm		schwarz / gold
95027-30-00	3000K	AG F	870lm		weiss matt
95027-30-12	3000K	AG F	870lm		weiss / schwarz
95027-30-02	3000K	AG F	870lm		schwarz matt

95026 – 9.3W Turn out LED Anbaustrahler

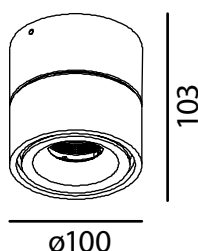

Spannung	220-240V AC, 50Hz (inkl. 500mA Konverter / dimmbar)
Schutzart	IP 20
Schutzklasse:	I
LED	bridgelux. V8
Leistung	9.3W
Farbwiedergabe Ra	80
Optik	Reflektor 45°
Dreh- und schwenkbar	35° / 90°
Aufbau	Montageplatte
Material Gehäuse	Aluminium
Massangaben	ø100 × 103mm

95026-27-00	2700K	AG F	835lm		weiss matt
95026-27-12	2700K	AG F	835lm		weiss / schwarz
95026-30-00	3000K	AG F	870lm		weiss matt
95026-30-12	3000K	AG F	870lm		weiss / schwarz



95040 – 9.2W Mini Tube LED Anbaustrahler

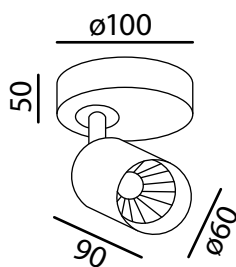

Spannung	220-240V AC, 50Hz (inkl. 500mA Konverter / dimmbar)
Schutzart	IP 20
Schutzklasse:	I
LED	bridgelux V8
Leistung	9.2W
Farbwiedergabe Ra	90
Optik	Reflektor 45° Schutzglas klar
Dreh- und schwenkbar	355° / 90°
Material Gehäuse	Aluminium
Anbau	Montageplatte
Massangaben	ø100 × 157mm

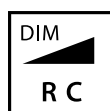

Phasenabschnitt dimmbar mit
Feller LED Universaldimmer
40200.LED

95040-27-00	2700K		863lm	<input type="checkbox"/>	weiss matt
95040-27-02	2700K		863lm	<input type="checkbox"/>	schwarz matt
95040-27-75	2700K		863lm	<input type="checkbox"/>	silberfarbig
95040-30-00	3000K		883lm	<input type="checkbox"/>	weiss matt
95040-30-02	3000K		883lm	<input type="checkbox"/>	schwarz matt
95040-30-75	3000K		883lm	<input type="checkbox"/>	silberfarbig

Filter

95055-SF60		Soft Filter
95055-SL60		Prisma Filter
95055-WB60		Waben Filter

Reflektoren

95055-RF60-30		transparent
95055-RF60-03		gold
95055-RF60-02		schwarz



Alle Preise excl. MwSt. und VRG.



95042 – 2 × 9.2W Mini Tube Line 2 LED Anbaustrahler

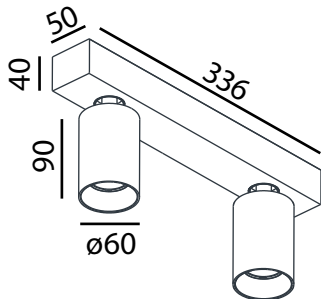

Spannung	220-240V AC, 50Hz (inkl. 500mA Konverter / dimmbar)
Schutzart	IP 20
Schutzklasse:	I
LED	bridgelux V8
Leistung	2 × 9.2W
Farbwiedergabe Ra	90
Optik	Reflektor 45° Schutzglas klar
Dreh- und schwenkbar	35° / 90°
Material Gehäuse	Aluminium
Anbau	Montageplatte
Massangaben	336 × 60 × 148mm



Phasenabschnitt dimmbar mit
Feller LED Universaldimmer
40200.LED

95042-27-00	2700K		2 × 863lm	<input type="checkbox"/>	weiss matt
95042-27-02	2700K		2 × 863lm	<input checked="" type="checkbox"/>	schwarz matt
95042-27-75	2700K		2 × 863lm	<input checked="" type="checkbox"/>	silberfarbig
95042-30-00	3000K		2 × 883lm	<input type="checkbox"/>	weiss matt
95042-30-02	3000K		2 × 883lm	<input checked="" type="checkbox"/>	schwarz matt
95042-30-75	3000K		2 × 883lm	<input checked="" type="checkbox"/>	silberfarbig

Filter



95055-SF60	<input type="checkbox"/>	Soft Filter
95055-SL60	<input type="checkbox"/>	Prisma Filter
95055-WB60	<input checked="" type="checkbox"/>	Waben Filter



Reflektoren

95055-RF60-30	<input type="checkbox"/>	transparent
95055-RF60-03	<input checked="" type="checkbox"/>	gold
95055-RF60-02	<input checked="" type="checkbox"/>	schwarz



95043 – 3 × 9.2W Mini Tube Line 3 LED Anbaustrahler

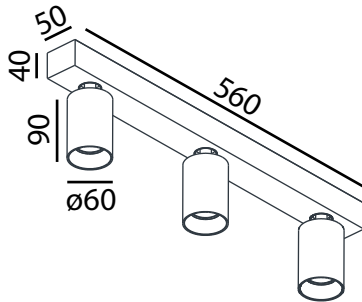

Spannung	220-240V AC, 50Hz (inkl. 500mA Konverter / dimmbar)
Schutzart	IP 20
Schutzklasse:	I
LED	bridgelux V8
Leistung	3 × 9.2W
Farbwiedergabe Ra	90
Optik	Reflektor 45° Schutzglas klar
Dreh- und schwenkbar	355° / 90°
Material Gehäuse	Aluminium
Anbau	Montageplatte
Massangaben	560 × 60 × 148mm



Phasenabschnitt dimmbar mit
Feller LED Universaldimmer
40200.LED

95043-27-00	2700K		3 × 863lm	<input type="checkbox"/>	weiss matt
95043-27-02	2700K		3 × 863lm	<input checked="" type="checkbox"/>	schwarz matt
95043-27-75	2700K		3 × 863lm	<input type="checkbox"/>	silberfarbig
95043-30-00	3000K		3 × 883lm	<input type="checkbox"/>	weiss matt
95043-30-02	3000K		3 × 883lm	<input checked="" type="checkbox"/>	schwarz matt
95043-30-75	3000K		3 × 883lm	<input type="checkbox"/>	silberfarbig

Filter

95055-SF60	<input type="checkbox"/>	Soft Filter
95055-SL60	<input type="checkbox"/>	Prisma Filter
95055-WB60	<input checked="" type="checkbox"/>	Waben Filter

Reflektoren

95055-RF60-30	<input type="checkbox"/>	transparent
95055-RF60-03	<input checked="" type="checkbox"/>	gold
95055-RF60-02	<input checked="" type="checkbox"/>	schwarz





95041 – 2 × 9.2W Mini Tube Duo LED Anbaustrahler

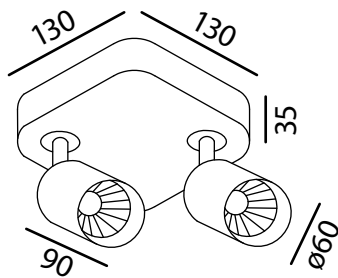

Spannung	220-240V AC, 50Hz (inkl. 500mA Konverter / dimmbar)
Schutzart	IP 20
Schutzklasse:	I
LED	bridgelux V8
Leistung	2 × 9.2W
Farbwiedergabe Ra	90
Optik	Reflektor 45° Schutzglas klar
Dreh- und schwenkbar	35° / 90°
Material Gehäuse	Aluminium
Anbau	Montageplatte
Massangaben	130 × 130 × 157mm



Phasenabschnitt dimmbar mit
Feller LED Universaldimmer
40200.LED

95041-27-00	2700K		2 × 863lm		weiss matt
95041-27-02	2700K		2 × 863lm		schwarz matt
95041-27-75	2700K		2 × 863lm		silberfarbig
95041-30-00	3000K		2 × 883lm		weiss matt
95041-30-02	3000K		2 × 883lm		schwarz matt
95041-30-75	3000K		2 × 883lm		silberfarbig

Filter

95055-SF60		Soft Filter
95055-SL60		Prisma Filter
95055-WB60		Waben Filter

Reflektoren

95055-RF60-30		transparent
95055-RF60-03		gold
95055-RF60-02		schwarz





95045 – 3 × 9.2W Mini Tube Trio LED Anbaustrahler

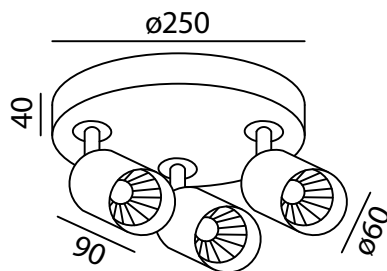

Spannung	220-240V AC, 50Hz (inkl. 500mA Konverter / dimmbar)
Schutzart	IP 20
Schutzklasse:	I
LED	bridgelux V8
Leistung	3 × 9.2W
Farbwiedergabe Ra	90
Optik	Reflektor 45° Schutzglas klar
Dreh- und schwenkbar	35° / 90°
Material Gehäuse	Aluminium
Anbau	Montageplatte
Massangaben	ø250 × 157mm



Phasenabschnitt dimmbar mit
Feller LED Universaldimmer
40200.LED

95045-27-00	2700K		3 × 863lm	<input type="checkbox"/>	weiss matt
95045-27-02	2700K		3 × 863lm	<input checked="" type="checkbox"/>	schwarz matt
95045-27-75	2700K		3 × 863lm	<input type="checkbox"/>	silberfarbig
95045-30-00	3000K		3 × 883lm	<input type="checkbox"/>	weiss matt
95045-30-02	3000K		3 × 883lm	<input checked="" type="checkbox"/>	schwarz matt
95045-30-75	3000K		3 × 883lm	<input type="checkbox"/>	silberfarbig

Filter

95055-SF60		Soft Filter
95055-SL60		Prisma Filter
95055-WB60		Waben Filter

Reflektoren

95055-RF60-30		transparent
95055-RF60-03		gold
95055-RF60-02		schwarz



63120 – 11W Moon 16 LED Anbauleuchte



Spannung	220-240V AC, 50Hz
Schutzart	IP 40
Schutzklasse:	I

LED **bridgelux**. 2835

Leistung	11W
Farbwiedergabe Ra	>90
Abstrahlwinkel	110°
Dimmbar	Mit Phasenabschnitt
Optik	Diffusor Opal
Material Gehäuse	Aluminium
Diffusor	Polycarbonat
Massangaben	ø160 × 60mm

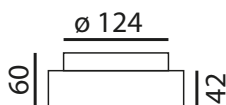

Phasenabschnitt dimmbar mit
Feller LED Universaldimmer
40200.LED

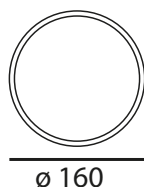

63120-27-00	2700K	A D	1089m	weiss matt
63120-27-02	2700K	A D	1089m	schwarz matt
63120-27-75	2700K	A D	1089m	silberfarbig
63120-30-00	3000K	A D	1210lm	weiss matt
63120-30-02	3000K	A D	1210lm	schwarz matt
63120-30-75	3000K	A D	1210lm	silberfarbig

63120 DA – 11W Moon 16 LED Anbauleuchte



Spannung	220-240V AC, 50Hz
Schutzart	IP 40
Schutzklasse:	I

LED **bridgelux**. 2835

Leistung	11W
Farbwiedergabe Ra	>90
Abstrahlwinkel	110°
Dimmbar	DALI
Optik	Diffusor Opal
Material Gehäuse	Aluminium
Diffusor	Polycarbonat
Massangaben	ø160 × 60mm

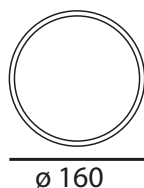
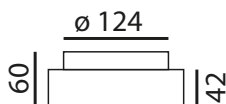

New	63120-27-00 DA	2700K	A D	1089m	weiss matt
New	63120-27-02 DA	2700K	A D	1089m	schwarz matt
New	63120-30-00 DA	3000K	A D	1210lm	weiss matt
New	63120-30-02 DA	3000K	A D	1210lm	schwarz matt

63121 DA – 14W Moon+ 26 LED Anbauleuchte

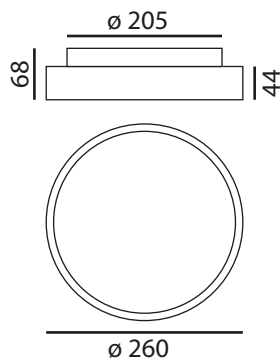
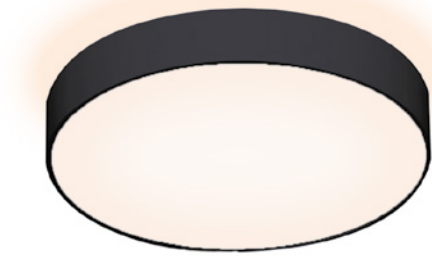

New	63121-27-00 DA	2700K		1253lm	<input type="checkbox"/> weiss matt
New	63121-27-02 DA	2700K		1253lm	<input checked="" type="checkbox"/> schwarz matt
New	63121-30-00 DA	3000K		1298lm	<input type="checkbox"/> weiss matt
New	63121-30-02 DA	3000K		1298lm	<input checked="" type="checkbox"/> schwarz matt



Spannung	220-240V AC, 50Hz
Schutzart	IP 40
Schutzklasse:	I

LED 2835

Leistung	14W
Farbwiedergabe Ra	>90
Abstrahlwinkel	110°
Dimmbar	DALI
Optik	Diffusor Opal & Indirekt
Material Gehäuse	Aluminium
Diffusor	Polycarbonat
Massangaben	ø260 × 68mm

63122 DA – 23W Moon+ 35 LED Anbauleuchte

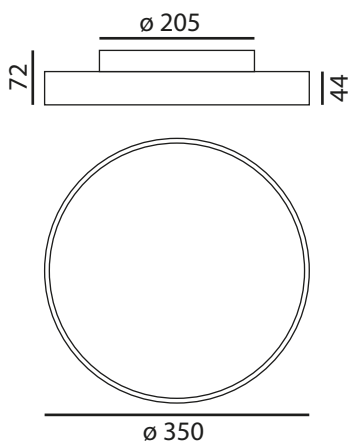

New	63122-27-00 DA	2700K		1947m	<input type="checkbox"/> weiss matt
New	63122-27-02 DA	2700K		1947m	<input checked="" type="checkbox"/> schwarz matt
New	63122-30-00 DA	3000K		2028lm	<input type="checkbox"/> weiss matt
New	63122-30-02 DA	3000K		2028lm	<input checked="" type="checkbox"/> schwarz matt



Spannung	220-240V AC, 50Hz
Schutzart	IP 40
Schutzklasse:	I

LED 2835

Leistung	23W
Farbwiedergabe Ra	>90
Abstrahlwinkel	110°
Dimmbar	DALI
Optik	Diffusor Opal & Indirekt
Material Gehäuse	Aluminium
Diffusor	Polycarbonat
Massangaben	ø350 × 72mm



Pendelleuchten 230V





105 95065-14
Orb 140



105 95065-20
Orb 200



106 95060
Tube 40



107 95062
Tube 60 Pro



109 95062
Tube 60 Pro

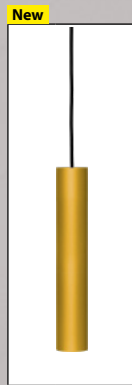

111 95072
Tube GU10



113 95070
Tube GU10



113 95071
Tube GU10

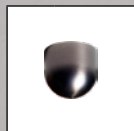

114 30013
Baldachin



114 30015-035
Baldachin



114 30015-050
Baldachin



115 30015-060
Baldachin



115 30015-230
2-fach Baldachin



115 30015-250
3-fach Baldachin



95065-14 – 12W Orb 140 Pendelleuchte

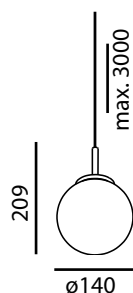

Strom DC	220mA (Bitte passenden Konverter dazu bestellen)
Schutzart	IP 20
Schutzklasse:	III
LED	Bridgelux 2835 SMD
Leistung	12W
Farbwiedergabe Ra	90
Optik	Diffusor Opal
Material Gehäuse	Aluminium / Glas
Massangaben	ø135 × 209mm

Kabel (max. 3m)

New	95065-14-27-02	2700K		1070lm		
New	95065-14-27-52	2700K		1070lm		
New	95065-14-27-57	2700K		1070lm		

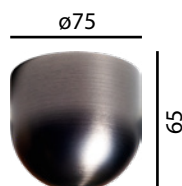

Baldachin

30013-01-00		weiss matt	inkl. 220mA 12W Konverter	[R C] dimmbar
30013-01-02		schwarz matt	inkl. 220mA 12W Konverter	[R C] dimmbar
30013-01-52		gun black	inkl. 220mA 12W Konverter	[R C] dimmbar
30013-01-57		bronze	inkl. 220mA 12W Konverter	[R C] dimmbar

95065-20 – 18W Orb 200 Pendelleuchte

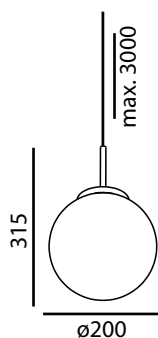

Strom DC	500mA (Bitte passenden Konverter dazu bestellen)
Schutzart	IP 20
Schutzklasse:	III
LED	Bridgelux 2835 SMD
Leistung	18W
Farbwiedergabe Ra	90
Optik	Diffusor Opal
Material Gehäuse	Aluminium / Glas
Massangaben	ø200 × 315mm

Kabel (max. 3m)

New	95065-20-27-02	2700K		1660lm		
New	95065-20-27-52	2700K		1660lm		
New	95065-20-27-57	2700K		1660lm		

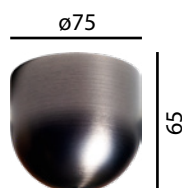

Baldachin

30013-02-00		weiss matt	inkl. 500mA 18W Konverter	[R C] dimmbar
30013-02-02		schwarz matt	inkl. 500mA 18W Konverter	[R C] dimmbar
30013-02-52		gun black	inkl. 500mA 18W Konverter	[R C] dimmbar
30013-02-57		bronze	inkl. 500mA 18W Konverter	[R C] dimmbar

95060 – 6.2W Tube 40 LED Pendelleuchte

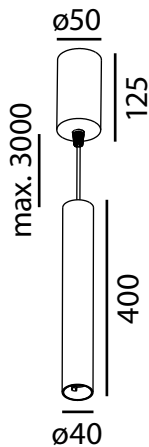

Spannung	220-240V AC, 50Hz (inkl. 350mA Konverter / dimmbar / im Baldachin)
Schutzart	IP 20
Schutzklasse:	I
LED	bridgelux V8
Leistung	6.2W
Farbwiedergabe Ra	90
Optik	Reflektor 35° Schutzglas klar
Material Gehäuse	Aluminium
Massangaben Leuchte	ø40 × 400mm
Baldachin	ø50 × 125mm



Phasenabschnitt dimmbar mit
Feller LED Universaldimmer
40200.LED

Artikelnummer	Farbtemperatur	Leistung	Farbwiedergabe	Strahlungsweite	Reflektor	Gehäuse	Kabel (max. 3m)
95060-27-00	2700K	6.2W	A	642lm	weiss matt	transparent	transparent
95060-27-02	2700K	6.2W	A	642lm	schwarz matt	schwarz	schwarz
95060-27-75	2700K	6.2W	A	642lm	silberfarbig	schwarz	schwarz
95060-30-00	3000K	6.2W	A	657lm	weiss matt	transparent	transparent
95060-30-02	3000K	6.2W	A	657lm	schwarz matt	schwarz	schwarz
95060-30-75	3000K	6.2W	A	657lm	silberfarbig	schwarz	schwarz

Reflektoren

95055-RF40-30	transparent
95055-RF40-03	gold
95055-RF40-02	schwarz

95062 – 9.2W Tube 60 Pro LED Pendelleuchte

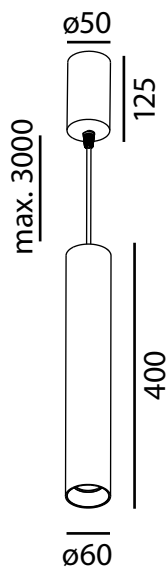

Spannung	220-240V AC, 50Hz (inkl. 500mA Konverter / dimmbar / im Leuchtenkörper)
Schutzart	IP 20
Schutzklasse:	I
LED	bridgelux V8
Leistung	9.2W
Farbwiedergabe Ra	90
Optik	Reflektor 43° Schutzglas klar
Material Gehäuse	Aluminium
Massangaben Leuchte	ø60 × 400mm
Baldachin	ø50 × 125mm



Phasenabschnitt dimmbar mit
Feller LED Universaldimmer
40200.LED

Code	Temperatur	Effizienz	Fluss	Farbe	Kabel (max. 3m)
95062-27-00	2700K	A F	863lm	weiss matt	transparent
95062-27-02	2700K	A F	863lm	schwarz matt	schwarz
95062-27-03	2700K	A F	863lm	gold	schwarz
95062-27-75	2700K	A F	863lm	silberfarbig	schwarz
95062-30-00	3000K	A F	883lm	weiss matt	transparent
95062-30-02	3000K	A F	883lm	schwarz matt	schwarz
95062-30-03	3000K	A F	883lm	gold	schwarz
95062-30-75	3000K	A F	883lm	silberfarbig	schwarz

Reflektoren

95055-RF60-30	transparent
95055-RF60-03	gold
95055-RF60-02	schwarz



95061 – 9.2W Tube 60 LED Pendelleuchte

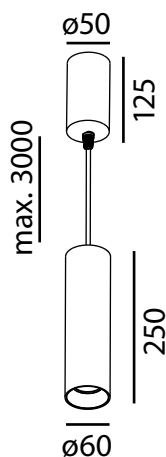

Spannung	220-240V AC, 50Hz (inkl. 500mA Konverter / dimmbar / im Leuchtenkörper)
Schutzart	IP 20
Schutzklasse:	I
LED	bridgelux. V8
Leistung	9.2W
Farbwiedergabe Ra	90
Optik	Reflektor 43° Schutzglas klar
Material Gehäuse	Aluminium
Massangaben Leuchte	ø60 × 250mm
Baldachin	ø50 × 125mm



Phasenabschnitt dimmbar mit
Feller LED Universaldimmer
40200.LED

				Kabel (max. 3m)	
95061-27-00	2700K	AGF	863lm	weiss matt	transparent
95061-27-02	2700K	AGF	863lm	schwarz matt	schwarz
95061-27-75	2700K	AGF	863lm	silberfarbig	schwarz
95061-30-00	3000K	AGF	883lm	weiss matt	transparent
95061-30-02	3000K	AGF	883lm	schwarz matt	schwarz
95061-30-75	3000K	AGF	883lm	silberfarbig	schwarz

Reflektoren

95055-RF60-30	transparent
95055-RF60-03	gold
95055-RF60-02	schwarz



95072 - Tube GU10 Pendelleuchte



Für Leuchtmittel Bauform ausschliesslich **PAR16**
(bitte dazu bestellen)

Fassung GU10 max. 7.5W

Schutzart IP 20

Schutzklasse I

Material Gehäuse Aluminium

Massangaben Leuchte $\varnothing 60 \times 350\text{mm}$



New 95072-00

weiss matt

Kabel (max 3m)

weiss

New 95072-02

schwarz

schwarz

New 95072-03

gold

schwarz

New 95072-52

gun black

schwarz



Reflektoren

95055-RF60-30 transparent

95055-RF60-03 gold

95055-RF60-02 schwarz



Filter

95055-SF60 Soft Filter

95055-SL60 Prisma Filter

95055-WB60 Waben Filter



GU10 Leuchtmittel

740018-27-01 **2700K** 380lm weiss

740018-27-75 **2700K** 380lm grau

740018-30-01 **3000K** 400lm weiss

740018-30-75 **3000K** 400lm grau



Zubehör

73160 Phasenabschnitt Dimmer | **3-25W** | 53×33×15mm

73163-05 Phasenabschnitt Dimmer | **200W** | 52×52×26mm



95070 / 95071 - E27 Pendelleuchte



Für Leuchtmittel Bauform	ausschliesslich E27 (bitte dazu bestellen)
Fassung	E27
Schutzart	IP 20
Schutzklasse	I
Material Gehäuse	Aluminium
Massangaben Leuchte	ø60 × 150mm

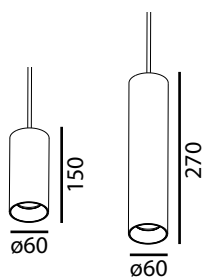

	L		Kabel (max 3m)
New 95070-00	150mm	<input type="checkbox"/> weiss matt	<input type="checkbox"/> weiss
New 95070-02	150mm	<input checked="" type="checkbox"/> schwarz	<input checked="" type="checkbox"/> schwarz
New 95071-00	270mm	<input type="checkbox"/> weiss matt	<input type="checkbox"/> weiss
New 95071-02	270mm	<input checked="" type="checkbox"/> schwarz	<input checked="" type="checkbox"/> schwarz

Zubehör



73160	Phasenabschnitt Dimmer	3-25W	53×33×15mm
73163-05	Phasenabschnitt Dimmer	200W	52×52×26mm

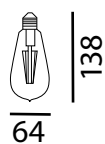

SAMSUNG CHIP Filament
6W E27 ST64
Bernstein

30083-27 **2200K**

Baldachin 1-fach

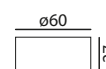

30015-060-00	<input type="checkbox"/> weiss matt
30015-060-02	<input checked="" type="checkbox"/> schwarz
30015-060-75	<input type="checkbox"/> silberfarbig

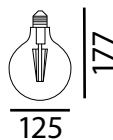

SAMSUNG CHIP Filament
6W E27 G125
Bernstein

30084-27 **2200K**

Baldachin 2-fach

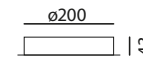

30015-230-00	<input type="checkbox"/> weiss matt
30015-230-02	<input checked="" type="checkbox"/> schwarz
30015-230-75	<input type="checkbox"/> silberfarbig

Baldachin 3-fach

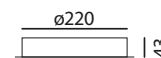

30015-250-00	<input type="checkbox"/> weiss matt
30015-250-02	<input checked="" type="checkbox"/> schwarz
30015-250-75	<input type="checkbox"/> silberfarbig

30013 – Baldachin für 1 Pendelleuchte

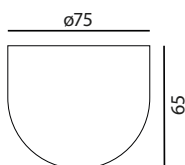

Schutzart	IP 20
Schutzklasse	I
Material Gehäuse	Aluminium
Massangaben	ø75 × 65mm

30013-00	<input type="checkbox"/> weiss matt	Mit Zugentlastung für Kabel ø3mm
30013-02	<input checked="" type="checkbox"/> schwarz matt	Mit Zugentlastung für Kabel ø3mm
30013-52	<input checked="" type="checkbox"/> gun black	Mit Zugentlastung für Kabel ø3mm
30013-57	<input checked="" type="checkbox"/> bronze	Mit Zugentlastung für Kabel ø3mm

30015-035 – Baldachin für 1 Pendelleuchte

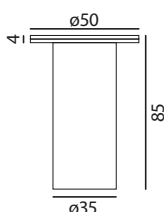

Schutzart	IP 20
Schutzklasse	I
Material Gehäuse	Metall
Massangaben Leuchte	ø35 × 85mm

30015-035-00	<input type="checkbox"/> weiss matt
30015-035-02	<input checked="" type="checkbox"/> schwarz

30015-050 – Baldachin für 1 Pendelleuchte

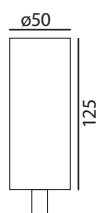

Schutzart	IP 20
Schutzklasse	I
Material Gehäuse	Metall
Massangaben Leuchte	ø50 × 125mm

30015-050-00	<input type="checkbox"/> weiss matt
30015-050-02	<input checked="" type="checkbox"/> schwarz
30015-050-75	<input checked="" type="checkbox"/> silberfarbig

30015-060 – Baldachin für 1 Pendelleuchte



Schutzart	IP 20
Schutzklasse	I
Material Gehäuse	Metall
Massangaben Leuchte	ø60 × 27mm

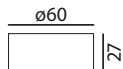

30015-060-00	weiss matt
30015-060-02	schwarz
30015-060-75	silberfarbig

30015-230 – Baldachin für 2 Pendelleuchten

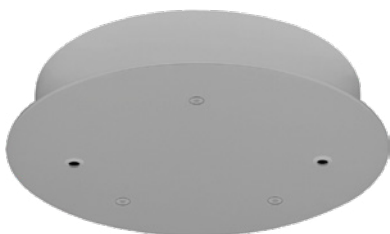

Schutzart	IP 20
Schutzklasse	I
Material Gehäuse	Metall
Massangaben Leuchte	ø230 × 43mm

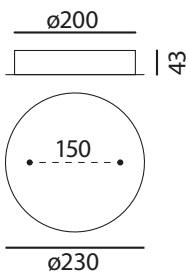

30015-230-00	weiss matt
30015-230-02	schwarz
30015-230-75	silberfarbig

30015-250 – Baldachin für 3 Pendelleuchten

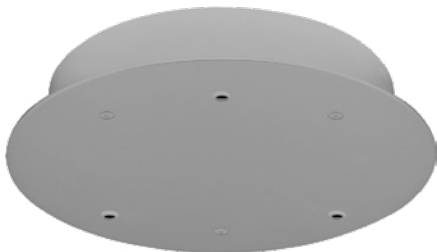

Schutzart	IP 20
Schutzklasse	I
Material Gehäuse	Metall
Massangaben Leuchte	ø250 × 43mm

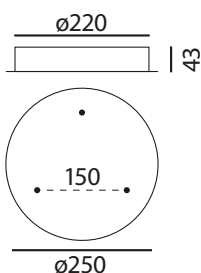

30015-250-00	weiss matt
30015-250-02	schwarz
30015-250-75	silberfarbig



Schienenstrahler

New



119 95046
Turn Track Mini



121 95030
Turn Track 9.3W



121 95031
Turn Track 13.8W

New



122 95022-10
Orb 10 Track

New



123 95022-14
Orb 14 Track



125 30030
Tube Track GU10



127 95055
Tube Track HV

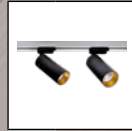

128 95056
Tube 60 Track

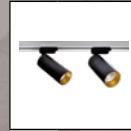

129 95056
Tube 60 Track DTW



130 95056
Tube 60 PRO



131 95056 DA
Tube 60 PRO DALI



133 95057
Twist Track



135
Anbaugehäuse



136
Anbaugehäuse



137
Anbaugehäuse



138 30020
Opus



138 30021
Domino



138 30022
Conos



139 20023
Zeno



139 3024
Focus



139 3025
Cano

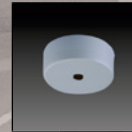

140
Anbaugehäuse



142 1 Phase
Aufbau

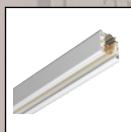

144 3 Phasen
Aufbau



144 3 Phasen
Einbau

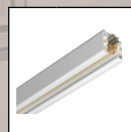

146 3 Phasen
Aufbau DALI



146 3 Phasen
Einbau DALI



148 3 Phasen
Track Konverter



95046 – 8.7W Turn Track Mini Schienenstrahler



Inklusive GLOBAL
1-Phasen Adapter



Spannung	220-240V AC, 50Hz (inkl. 250mA Konverter / dimmbar)
Schutzart	IP 20
Schutzklasse:	I
LED	bridgelux V8 GEM
Leistung	8.7W
Farbwiedergabe Ra	90
Optik	Reflektor 46°
Dreh- und schwenkbar	35° / 65°
Material Gehäuse	Aluminium
Massangaben	ø84 × 126mm



Phasenabschnitt dimmbar mit
Feller LED Universaldimmer
40200.LED

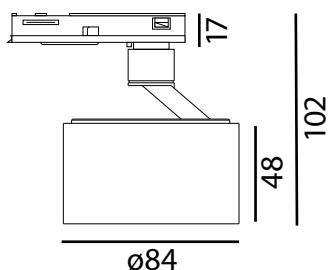

New	95046-27-00	2700K		1155lm		weiss matt
New	95046-27-02	2700K		1155lm		schwarz matt
New	95046-27-52	2700K		1155lm		gun black
New	95046-27-75	2700K		1155lm		silberfarbig
New	95046-30-00	3000K		1157lm		weiss matt
New	95046-30-02	3000K		1157lm		schwarz matt
New	95046-30-52	3000K		1157lm		gun black
New	95046-30-75	3000K		1157lm		silberfarbig



95030 – 9.3W Turn Track Schienenstrahler



Inklusive GLOBAL
3-Phasen Adapter



Spannung 220-240V AC, 50Hz
(inkl. 500mA Konverter / dimmbar)

Schutzart IP 20
Schutzklasse: I

LED **bridgelux** V8

Leistung 9.3W

Farbwiedergabe Ra 80

Optik Reflektor 45°

Dreh- und schwenkbar 35° / 90°

Material Gehäuse Aluminium

Massangaben $\varnothing 100 \times 103\text{mm}$



Phasenabschnitt dimmbar mit
Feller LED Universaldimmer
40200.LED

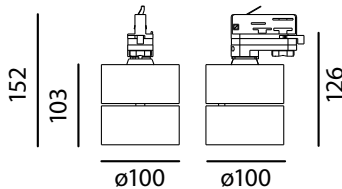

95030-27-00	2700K		835lm		weiss matt
95030-27-12	2700K		835lm		weiss / schwarz
95030-30-00	3000K		870lm		weiss matt
95030-30-12	3000K		870lm		weiss / schwarz

95031 – 13.8W Turn Track Schienenstrahler



Inklusive GLOBAL
3-Phasen Adapter



Spannung 220-240V AC, 50Hz
(inkl. 500mA Konverter / dimmbar)

Schutzart IP 20
Schutzklasse: I

LED **bridgelux** V10

Leistung 13.8W

Farbwiedergabe Ra 90

Optik Reflektor 45°

Dreh- und schwenkbar 35° / 90°

Material Gehäuse Aluminium

Massangaben $\varnothing 100 \times 103\text{mm}$



Phasenabschnitt dimmbar mit
Feller LED Universaldimmer
40200.LED

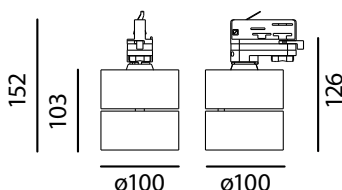

95031-27-02	2700K		1311lm		schwarz matt
95031-27-23	2700K		1311lm		schwarz / gold
95031-30-02	3000K		1375lm		schwarz matt

95022-10 / 95023-10 – 7.8W Orb 10 Track



Spannung	220-240V AC, 50Hz (inkl. 200mA Konverter / dimmbar)
Schutzart	IP 20
Schutzklasse:	I
LED	bridgelux. SMB 2835
Leistung	7.8W
Farbwiedergabe Ra	90
Optik	Diffusor opal
Material Gehäuse	Aluminium / Glas
Massangaben	ø100 × 148mm

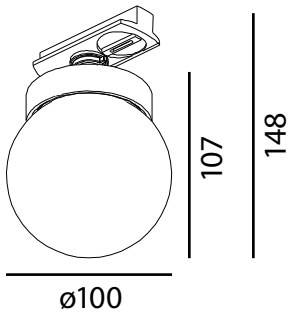

Phasenabschnitt dimmbar mit
Feller LED Universaldimmer
40200.LED



Inklusive **GLOBAL GB 66** 1-Phasen Stromschienenadapter

New	95022-10-27-00	2700K	A B E	897lm	weiss matt
New	95022-10-27-02	2700K	A B E	897lm	schwarz matt
New	95022-10-30-00	3000K	A B D	975lm	weiss matt
New	95022-10-30-02	3000K	A B D	975lm	schwarz matt



Inklusive **GLOBAL GA 69** 3-Phasen Stromschienenadapter

New	95023-10-27-00	2700K	A B E	897lm	weiss matt
New	95023-10-27-02	2700K	A B E	897lm	schwarz matt
New	95023-10-30-00	3000K	A B D	975lm	weiss matt
New	95023-10-30-02	3000K	A B D	975lm	scschwarz matt



Inklusive 3-Phasen DALI In Track Konverter (kompatibel mit **GLOBAL Trac Pulse**)

New	95023-10-27-00 DA	2700K	A B E	897lm	weiss matt
New	95023-10-27-02 DA	2700K	A B E	897lm	schwarz matt
New	95023-10-30-00 DA	3000K	A B D	975lm	weiss matt
New	95023-10-30-02 DA	3000K	A B D	975lm	scschwarz matt

95022-14 / 95023-14 – 9.7W Orb 14 Track



Spannung	220-240V AC, 50Hz (inkl. 250mA Konverter / dimmbar)
Schutzart	IP 20
Schutzklasse:	I
LED	bridgelux. SMB 2835
Leistung	9.7W
Farbwiedergabe Ra	90
Optik	Diffusor opal
Material Gehäuse	Aluminium / Glas
Massangaben	ø135 × 182mm

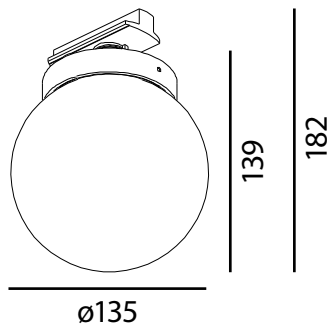

Phasenabschnitt dimmbar mit
Feller LED Universaldimmer
40200.LED



Inklusive **GLOBAL GB 66** 1-Phasen Stromschienenadapter

New	95022-14-27-00	2700K		1070lm		weiss matt
New	95022-14-27-02	2700K		1070lm		schwarz matt
New	95022-14-30-00	3000K		1150lm		weiss matt
New	95022-14-30-02	3000K		1150lm		schwarz matt



Inklusive **GLOBAL GA 69** 3-Phasen Stromschienenadapter

New	95023-14-27-00	2700K		1070lm		weiss matt
New	95023-14-27-02	2700K		1070lm		schwarz matt
New	95023-14-30-00	3000K		1150lm		weiss matt
New	95023-14-30-02	3000K		1150lm		scschwarz matt



Inklusive 3-Phasen DALI In Track Konverter (kompatibel mit **GLOBAL Trac Pulse**)

New	95023-14-27-00	2700K		1070lm		weiss matt
New	95023-14-27-02	2700K		1070lm		schwarz matt
New	95023-14-30-00	3000K		1150lm		weiss matt
New	95023-14-30-02	3000K		1150lm		scschwarz matt



30030 / 30031 – Tube Track GU10 LED Schienenstrahler



Für Leuchtmittel Bauform	ausschliesslich LED GU10 bis max. 5W
Fassung	GU10 integriert
Schutzart	IP 20
Schutzklasse:	I
Material Gehäuse	Aluminium
Dreh- und schwenkbar	355° / 90°
Massangaben	ø60 × 90mm

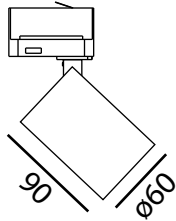

Inklusive GLOBAL 1-Phasen Stromschienenadapter

New	30030-00		weiss matt
	30030-12		weiss matt / schwarz
	30030-02		schwarz matt *
	30030-75		silberfarbig



Inklusive GLOBAL 3-Phasen Stromschienenadapter

New	30031-00		weiss matt
	30031-12		weiss matt / schwarz
	30031-02		schwarz matt *
	30031-75		silberfarbig

Filter

95055-SF60		Soft Filter
95055-SL60		Prisma Filter
95055-WB60		Waben Filter

Reflektoren

95055-RF60-30		transparent
95055-RF60-03		gold
95055-RF60-02		schwarz

GU10 Leuchtmittel

740018-27-01	2700K		380lm		weiss
740018-27-75	2700K		380lm		grau
740018-30-01	3000K		400lm		weiss
740018-30-75	3000K		400lm		grau

Dim to Warm GU10 Leuchtmittel

740018-50-01	2200–3000K		380lm		weiss
740018-50-75	2200–3000K		380lm		grau





95055 – 8W Tube Track HV LED Schienenstrahler

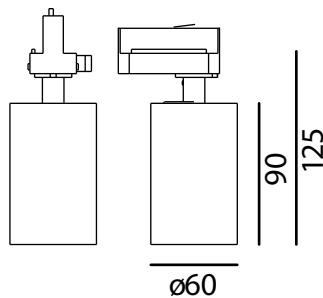

Spannung	220-240V AC, 50Hz (230V AC LED / dimmbar)	
Schutzart	IP 20	
Schutzklasse:	I	
LED	Lumens	EDC33C
Leistung	8W	
Farbwiedergabe Ra	90	
Optik	Reflektor 38° (26° auf Anfrage)	
Material Gehäuse	Aluminium	
Dreh- und schwenkbar	355° / 90°	
Massangaben	ø60 × 160mm	

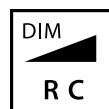

Phasenabschnitt dimmbar mit
Feller LED Universaldimmer
40200.LED



Inklusive GLOBAL 1-Phasen Stromschienenadapter

95055-27-00	2700K		680lm		weiss matt
95055-27-02	2700K		680lm		schwarz matt
95055-27-23	2700K		680lm		schwarz matt / gold
95055-27-75	2700K		680lm		silberfarbig
95055-30-00	3000K		760 lm		weiss matt
95055-30-02	3000K		760 lm		schwarz matt
95055-30-23	3000K		760 lm		schwarz matt / gold
95055-30-75	3000K		760 lm		silberfarbig

Reflektoren

95055-RF60-30		transparent
95055-RF60-03		gold
95055-RF60-02		schwarz

95056 – 12.2W Tube 60 Track LED Schienenstrahler

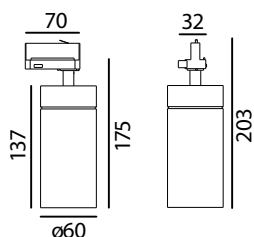

Inklusive GLOBAL PULSE 3-Phasen DALI Adapter

New	95056-27-00 DA	2700K		1456lm		weiss matt
New	95056-27-02 DA	2700K		1456lm		schwarz matt
New	95056-30-00 DA	3000K		1525lm		weiss matt
New	95056-30-02 DA	3000K		1525lm		schwarz matt



Phasenabschnitt dimmbar mit
Feller LED Universaldimmer
40200.LED



Inklusive GLOBAL 3-Phasen Adapter

95056-27-00	2700K		1456lm		weiss matt
95056-27-02	2700K		1456lm		schwarz matt
95056-27-23	2700K		1456lm		schwarz matt / gold
95056-27-75	2700K		1456lm		silberfarbig
95056-30-00	3000K		1525lm		weiss matt
95056-30-02	3000K		1525lm		schwarz matt
95056-30-23	3000K		1525lm		schwarz matt / gold
95056-30-75	3000K		1525lm		silberfarbig

Filter

95055-SF60		Soft Filter
95055-SL60		Prisma Filter
95055-WB60		Waben Filter

Reflektoren

95055-RF60-30		transparent
95055-RF60-03		gold
95055-RF60-02		schwarz



95056 – 13W Tube 60 DTW Track LED Schienenstrahler Dim to Warm



Spannung	220-240V AC, 50Hz (inkl. 350mA Konverter / dimmbar)	
Schutzart	IP 20	
Schutzklasse:	I	
LED	Prolight Optio	PDSQ-17VFL (DTW)
Leistung	13W	
Farbwiedergabe Ra	90	
Optik	Reflektor 48° (24° / 33° auf Anfrage)	
Dreh- und schwenkbar	35° / 90°	
Massangaben	ø60 × 160mm	

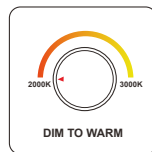
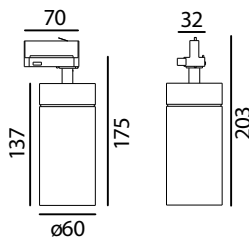

Dim to Warm Funktion nur mit einem Phasenabschnitt Dimmer möglich, z.B. Feller LED Universaldimmer 40200.LED

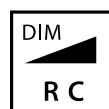

Phasenabschnitt dimmbar mit Feller LED Universaldimmer 40200.LED



Inklusive GLOBAL 3-Phasen Adapter

95056-50-00	2000–3000K	A F G	1100lm		weiss matt
95056-50-02	2000–3000K	A F G	1100lm		schwarz matt
95056-50-23	2000–3000K	A F G	1100lm		schwarz/gold
95056-50-75	2000–3000K	A F G	1100lm		silberfarbig

Filter



95055-SF60		Soft Filter
95055-SL60		Prisma Filter
95055-WB60		Waben Filter

Reflektoren



95055-RF60-30		transparent
95055-RF60-03		gold
95055-RF60-02		schwarz

95058 – 18.1W Tube 60 PRO LED Schienenstrahler

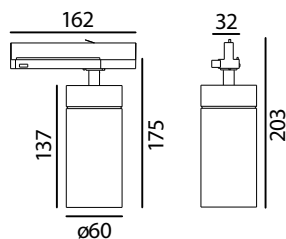

Spannung	220-240V AC, 50Hz (Stromquelle 350mA / nicht dimmbar)
Schutzart	IP 20
Schutzklasse:	
LED	bridgelux V10c
Leistung	18.1W
Farbwiedergabe Ra	90
Optik	Reflektor 48° (25° / 36° auf Anfrage) Schutzglas klar
Material Gehäuse	Aluminium
Dreh- und schwenkbar	355° / 90°
Massangaben	ø60 x 175mm



New	95058-30-00	3000K	A E	1887lm	weiss matt
New	95058-30-02	3000K	A E	1887lm	schwarz matt
New	95058-30-75	3000K	A E	1887lm	silberfarbig
New	95058-40-00	4000K	A D	2516lm	weiss matt
New	95058-40-02	4000K	A D	2516lm	schwarz matt
New	95058-40-75	4000K	A D	2516lm	silberfarbig

Filter

95055-SF60	t	Soft Filter
95055-SL60	t	Prisma Filter
95055-WB60	■	Waben Filter

Reflektoren

95055-RF60-30	t	transparent
95055-RF60-03	■	gold
95055-RF60-02	■	schwarz



95058 – 18.1W Tube 60 PRO LED Schienenstrahler

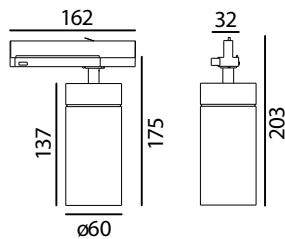

Spannung	220-240V AC, 50Hz (Stromquelle 350mA / DALI dimmbar)
Schutzart	IP 20
Schutzklasse:	
LED	bridgelux V10c
Leistung	18.1W
Farbwiedergabe Ra	90
Optik	Reflektor 48° (25° / 36° auf Anfrage)
Material Gehäuse	Aluminium
Dreh- und schwenkbar	355° / 90°
Massangaben	ø60 × 175mm



95058-30-00DA	3000K		1887ml		weiss matt
95058-30-02DA	3000K		1887ml		schwarz matt
95058-30-75DA	3000K		1887ml		silberfarbig
95058-40-00DA	4000K		2516lm		weiss matt
95058-40-02DA	4000K		2516lm		schwarz matt
95058-40-75DA	4000K		2516lm		silberfarbig

Filter

95055-SF60		Soft Filter
95055-SL60		Prisma Filter
95055-WB60		Waben Filter

Reflektoren

95055-RF60-30		transparent
95055-RF60-03		gold
95055-RF60-02		schwarz





95057 – 9.4W Twist Track LED Schienenstrahler Dim to Warm



Spannung	220-240V AC, 50Hz (inkl. 500mA Konverter / dimmbar)	
Schutzart	IP 20	
Schutzklasse:	I	
LED	Prolight	PDSQ-10VFL (DTW)
	Optio	
Leistung	9.4W	
Farbwiedergabe Ra	90	
Optik	Reflektor 48° (24° / 34° auf Anfrage)	
Dreh- und schwenkbar	35° / 90°	
Massangaben	ø65 × 200mm	

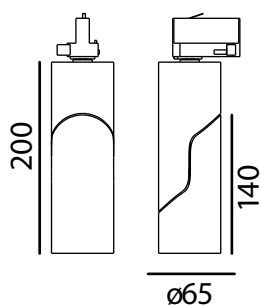

Inklusive GLOBAL 3-Phasen Adapter

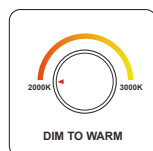

Dim to Warm Funktion nur mit einem PhasenABSchnitt Dimmer möglich, z.B. Feller LED Universaldimmer 40200.LED

95057-50-00	2000–3000K	A F G	919lm		weiss matt
95057-50-23	2000–3000K	A F G	919lm		schwarz/gold
95057-50-75	2000–3000K	A F G	919lm		silberfarbig

Filter		
95055-SF60	Soft Filter	8.50 CHF
95055-SL60	Prisma Filter	8.50 CHF
95055-WB60	Waben Filter	8.50 CHF





95081 – Linear Focus für 3-Phasen Stromschiene



Spannung	220-240V AC, 50Hz
Schutzart	IP 20
Schutzklasse:	I

LED **SAMSUNG**

Farbwiedergabe Ra	90
Farbtemperatur	Einstellbar
Leistung	Einstellbar
Optik	Reflektoren 50° (UGR<16)
Material Gehäuse	Aluminium
Massangaben	602 × 32 × 22mm
(Sichtbarer Anteil)	1082 × 32 × 22mm

Kompatibel mit 3-Phasen Stromschienen der Marken:
Global / Eutrack / Stucchi / Powergear

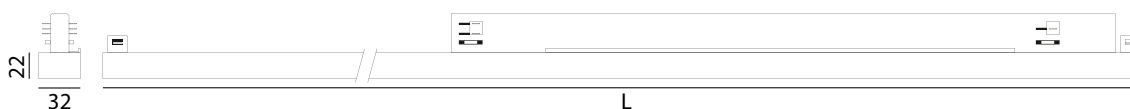

		Leistung		L	
95081-060-00 DA	3000/4000/5000K	6-13W	780/1690lm	602mm	<input type="checkbox"/> weiss
95081-060-02 DA	3000/4000/5000K	6-13W	780/1690lm	602mm	<input checked="" type="checkbox"/> schwarz
95081-120-00 DA	3000/4000/5000K	18-34W	2340/4420lm	1082mm	<input type="checkbox"/> weiss
95010-120-02 DA	3000/4000/5000K	18-34W	2340/4420lm	1082mm	<input checked="" type="checkbox"/> schwarz

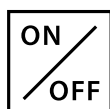

		Leistung		L	
95081-060-00	3000/4000/5000K	9-17W	780/1690lm	602mm	<input type="checkbox"/> weiss
95081-060-02	3000/4000/5000K	9-17W	780/1690lm	602mm	<input checked="" type="checkbox"/> schwarz
95081-120-00	3000/4000/5000K	18-34W	2340/4420lm	1082mm	<input type="checkbox"/> weiss
95081-120-02	3000/4000/5000K	18-34W	2340/4420lm	1082mm	<input checked="" type="checkbox"/> schwarz

95080 – Linear Micro Prisma für 3-Phasen Stromschiene



Spannung	220-240V AC, 50Hz
Schutzart	IP 20
Schutzklasse:	I
LED SAMSUNG	
Farbwiedergabe Ra	90
Farbtemperatur	Einstellbar
Leistung	Einstellbar
Optik	Microprisma 87° (UGR<22)
Material Gehäuse	Aluminium
Massangaben	584 × 32 × 22mm
(Sichtbarer Anteil)	1124 × 32 × 22mm

Kompatibel mit 3-Phasen Stromschienen der Marken:
Global / Eutrack / Stucchi / Powergear

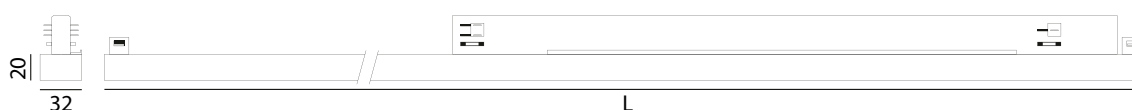

	Leistung		L	
95080-060-00 DA	3000/4000/5000K	9-17W 1080/2040lm	584mm	<input type="checkbox"/> weiss
95080-060-02 DA	3000/4000/5000K	9-17W 1080/2040lm	584mm	<input checked="" type="checkbox"/> schwarz
95080-120-00 DA	3000/4000/5000K	18-34W 2160/4080lm	1124mm	<input type="checkbox"/> weiss
95080-120-02 DA	3000/4000/5000K	18-34W 2160/4080lm	1124mm	<input checked="" type="checkbox"/> schwarz

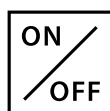

	Leistung		L	
95080-060-00	3000/4000/5000K	9-17W 1080/2040lm	584mm	<input type="checkbox"/> weiss
95080-060-02	3000/4000/5000K	9-17W 1080/2040lm	584mm	<input checked="" type="checkbox"/> schwarz
95080-120-00	3000/4000/5000K	18-34W 2160/4080lm	1124mm	<input type="checkbox"/> weiss
95080-120-02	3000/4000/5000K	18-34W 2160/4080lm	1124mm	<input checked="" type="checkbox"/> schwarz

95082 – Linear Lens für 3-Phasen Stromschiene



Spannung	220-240V AC, 50Hz
Schutzart	IP 20
Schutzklasse:	I

LED **SAMSUNG**

Farbwiedergabe Ra	90
Farbtemperatur	Einstellbar
Leistung	Einstellbar
Optik	Linsen wählbar (UGR<19)
Material Gehäuse	Aluminium
Massangaben	564 × 32 × 22mm
(Sichtbarer Anteil)	1124 × 32 × 22mm

Kompatibel mit 3-Phasen Stromschienen der Marken:
Global / Eutrack / Stucchi / Powergear

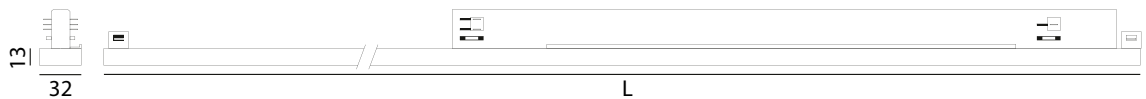

	Leistung		L	
95082-060-00 DA	3000/4000/5000K	9-17W	1350/2550lm	564mm <input type="checkbox"/> weiss
95082-060-02 DA	3000/4000/5000K	9-17W	1350/2550lm	564mm <input checked="" type="checkbox"/> schwarz
95082-120-00 DA	3000/4000/5000K	18-34W	2700/5100lm	1124mm <input type="checkbox"/> weiss
95082-120-02 DA	3000/4000/5000K	18-34W	2700/5100lm	1124mm <input checked="" type="checkbox"/> schwarz

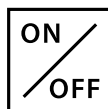

	Leistung		L	
95082-060-00	3000/4000/5000K	9-17W	1350/2550lm	564mm <input type="checkbox"/> weiss
95082-060-02	3000/4000/5000K	9-17W	1350/2550lm	564mm <input checked="" type="checkbox"/> schwarz
95082-120-00	3000/4000/5000K	18-34W	2700/5100lm	1124mm <input type="checkbox"/> weiss
95082-120-02	3000/4000/5000K	18-34W	2700/5100lm	1124mm <input checked="" type="checkbox"/> schwarz

Abstrahlwinkel

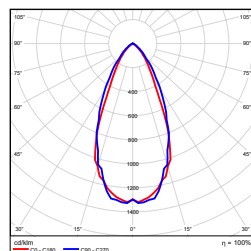

60°

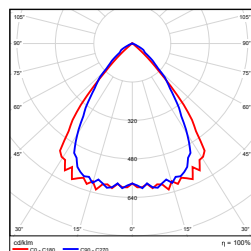

90°

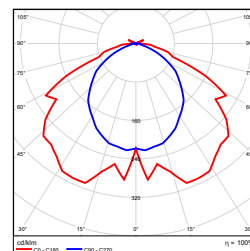

110°

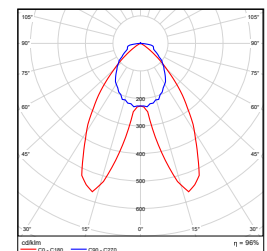

2 × 25° asymmetrisch

Linsen

95082-LS60	280mm Linsensegment 60°
95082-LS90	280mm Linsensegment 90°
95082-LS110	280mm Linsensegment 110°
95082-LS2X25	280mm Linsensegment 2 × 25° asymmetrisch

30020 – Opus Aufbaustrahler

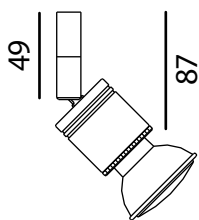

Für Leuchtmittel Bauform	ausschliesslich PAR16 (bitte dazu bestellen)
Fassung	GU10 integriert
Schutzart	IP 20
Schutzklasse:	I
Material Gehäuse	Aluminium
Dreh- und schwenkbar	355° / 90°
Montage	mit M10 × 1
Massangaben	L 118mm

- 30020-01 weiss
- 30020-04 chrom
- 30020-05 nickel satin
- 30020-55 nickel poliert
- 30020-75 silbergrau

30021 – Domino Aufbaustrahler

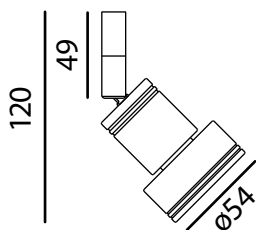

Für Leuchtmittel Bauform	ausschliesslich PAR16 (bitte dazu bestellen)
Fassung	GU10 integriert
Schutzart	IP 20
Schutzklasse:	I
Material Gehäuse	Aluminium
Dreh- und schwenkbar	355° / 90°
Montage	mit M10 × 1
Massangaben	L 129mm

- 30021-01 weiss
- 30021-02 schwarz matt
- 30021-04 chrom
- 30021-05 nickel satin
- 30021-55 nickel poliert
- 30021-75 silbergrau

30022 – Conos Aufbaustrahler

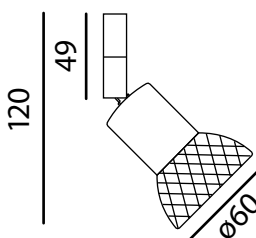

Für Leuchtmittel Bauform	ausschliesslich PAR16 (bitte dazu bestellen)
Fassung	GU10 integriert
Schutzart	IP 20
Schutzklasse:	I
Material Gehäuse	Aluminium
Dreh- und schwenkbar	355° / 90°
Montage	mit M10 × 1
Massangaben	L 122mm

- 30022-01 weiss
- 30022-04 chrom
- 30022-05 nickel satin
- 30022-55 nickel poliert
- 30022-75 silbergrau

30023 – Zeno Aufbaustrahler

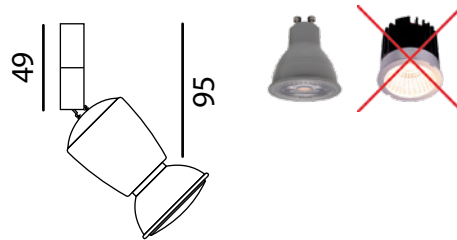

Für Leuchtmittel Bauform	ausschliesslich PAR16 (bitte dazu bestellen)
Fassung	GU10 integriert
Schutzart	IP 20
Schutzklasse:	I
Material Gehäuse	Aluminium
Dreh- und schwenkbar	35° / 90°
Montage	mit M10 × 1
Massangaben	L 127mm

30023-01	weiss
30023-04	chrom
30023-05	nickel satin
30023-55	nickel poliert
30023-75	silbergrau

30024 – Focus Aufbaustrahler

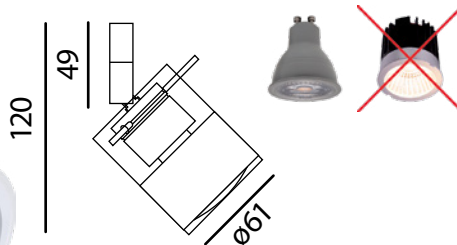

Für Leuchtmittel Bauform	ausschliesslich PAR16 (bitte dazu bestellen)
Fassung	GU10 integriert
Schutzart	IP 20
Schutzklasse:	I
Material Gehäuse	Aluminium
Dreh- und schwenkbar	35° / 90°
Montage	mit M10 × 1
Massangaben	L 120mm

30024-01	weiss
30024-04	chrom
30024-05	nickel satin
30024-55	nickel poliert
30024-75	silbergrau

30025 – Cano Aufbaustrahler

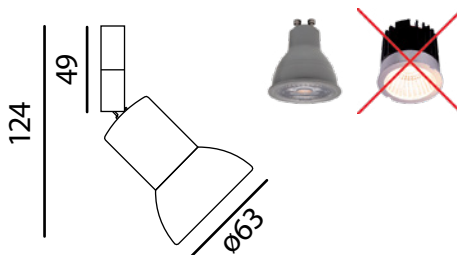

Für Leuchtmittel Bauform	ausschliesslich PAR16 (bitte dazu bestellen)
Fassung	GU10 integriert
Schutzart	IP 20
Schutzklasse:	I
Material Gehäuse	Aluminium
Dreh- und schwenkbar	35° / 90°
Montage	mit M10 × 1
Massangaben	L 125mm

30025-01	weiss
30025-04	chrom
30025-05	nickel satin
30025-55	nickel poliert
30025-75	silbergrau

Glas als weisse oder
blaue Version erhältlich

30001 – Anbaugehäuse rund

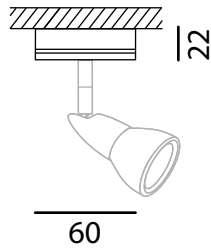
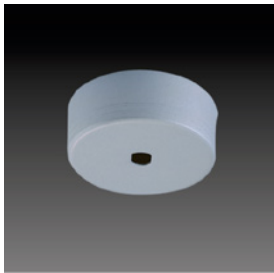

Schutzart	IP 20
Für Montage	mit M10 × 1
Abmessungen	ø60 × 22mm

30001-01	<input type="checkbox"/> weiss
30001-04	<input type="checkbox"/> chrom
30001-05	<input type="checkbox"/> nickel satin
30001-55	<input type="checkbox"/> nickel poliert
30001-75	<input type="checkbox"/> silberfarbig

Alle Preise excl. MwSt. und VRG.

30002 – Anbaugehäuse rund

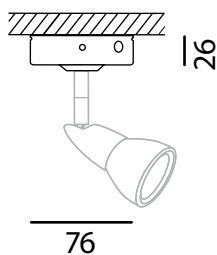

Schutzart	IP 20
Für Montage	mit M10 × 1
Abmessungen	ø76 × 26mm

30002-01	<input type="checkbox"/> weiss
30002-04	<input type="checkbox"/> chrom
30002-05	<input type="checkbox"/> nickel satin
30002-55	<input type="checkbox"/> nickel poliert
30002-75	<input type="checkbox"/> silberfarbig

Alle Preise excl. MwSt. und VRG.

30003 – Einbaumodul rund

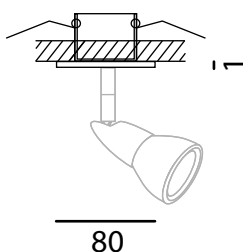
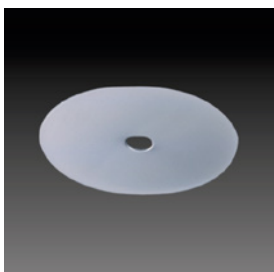

Schutzart	IP 20
Für Montage	mit M10 × 1
Abmessungen	ø80 × 11mm

30003-01	<input type="checkbox"/> weiss
30003-04	<input type="checkbox"/> chrom
30003-05	<input type="checkbox"/> nickel satin
30003-55	<input type="checkbox"/> nickel poliert
30003-75	<input type="checkbox"/> silberfarbig

Alle Preise excl. MwSt. und VRG.

30004 – Aufbaugehäuse eckig

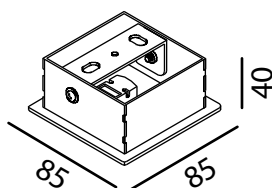

Schutzart	IP 20
Für Montage	mit M10 × 1
Abmessungen	L85 × 85mm / 40mm

30004-01	<input type="checkbox"/> weiss
30004-04	<input type="checkbox"/> chrom
30004-05	<input type="checkbox"/> nickel satin
30004-55	<input type="checkbox"/> nickel poliert
30004-75	<input type="checkbox"/> silberfarbig

Alle Preise excl. MwSt. und VRG.

30005 – Aufbaugehäuse eckig

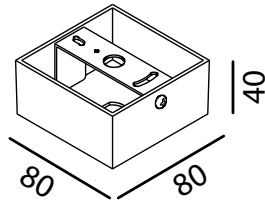
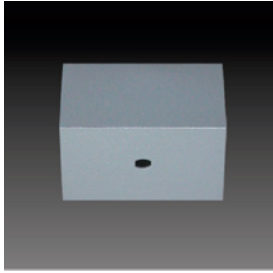

Schutzart IP 20

Für Montage mit M10 × 1

Abmessungen L80 × 80mm / 40mm

30005-01	<input type="checkbox"/>	weiss
30005-04	<input type="checkbox"/>	chrom
30005-05	<input type="checkbox"/>	nickel satin
30005-55	<input type="checkbox"/>	nickel poliert
30005-75	<input type="checkbox"/>	silberfarbig

Alle Preise excl. MwSt. und VRG.

30006 – Aufbaugehäuse eckig

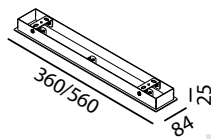
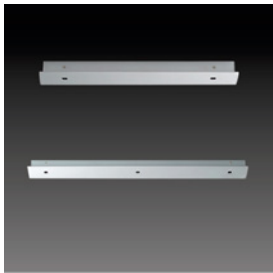

Schutzart IP 20

Für Montage mit M10 × 1

Abmessungen L82 × 360mm/560mm / 40mm

L360mm

30006-01	<input type="checkbox"/>	weiss
30006-04	<input type="checkbox"/>	chrom
30006-05	<input type="checkbox"/>	nickel satin
30006-55	<input type="checkbox"/>	nickel poliert
30006-75	<input type="checkbox"/>	silberfarbig

L560mm

3007-01	<input type="checkbox"/>	weiss
3007-04	<input type="checkbox"/>	chrom
3007-05	<input type="checkbox"/>	nickel satin
3007-55	<input type="checkbox"/>	nickel poliert
3007-75	<input type="checkbox"/>	silberfarbig

Alle Preise excl. MwSt. und VRG.

30009 – Anbaugehäuse eckig

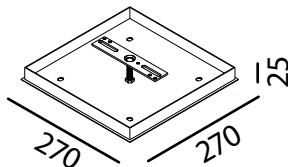

Schutzart IP 20

Für Montage mit M10 × 1

Abmessungen L270 × 270mm / 40mm

30009-01	<input type="checkbox"/>	weiss
30009-04	<input type="checkbox"/>	chrom
30009-05	<input type="checkbox"/>	nickel satin
30009-55	<input type="checkbox"/>	nickel poliert
30009-75	<input type="checkbox"/>	silberfarbig

Alle Preise excl. MwSt. und VRG.

30008 – Aufbaugehäuse rund

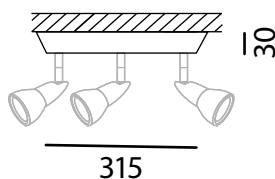

Schutzart IP 20

Für Montage mit M10 × 1

Abmessungen ø315 × 30mm

30008-01	<input type="checkbox"/>	weiss
30008-04	<input type="checkbox"/>	chrom
30008-05	<input type="checkbox"/>	nickel satin
30008-55	<input type="checkbox"/>	nickel poliert
30008-75	<input type="checkbox"/>	silberfarbig

Alle Preise excl. MwSt. und VRG.

GLOBAL TRACK BASE 230V AC 1-Phasen Stromschiene

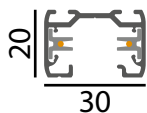
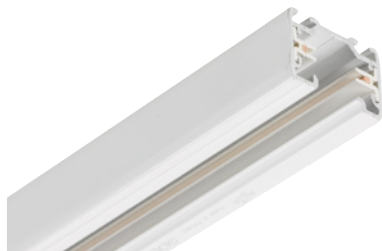

1-Phase Aufbau Stromschiene

	weiss matt	schwarz	Aluminium
L=1m	GB 2100-3	GB 2100-2	GB 2100-1
L=2m	GB 2200-3	GB 2200-2	GB 2200-1
L=3m	GB 2300-3	GB 2300-2	GB 2300-1

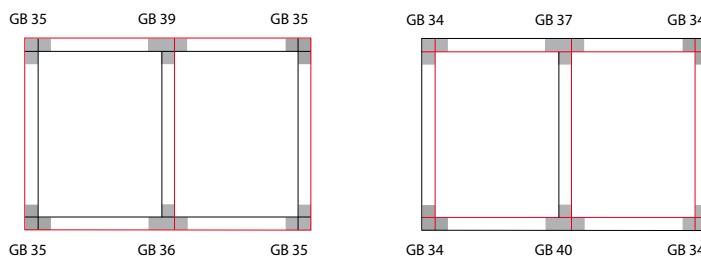
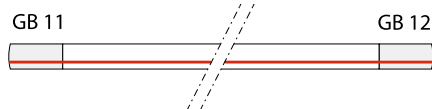

	weiss matt	schwarz	Aluminium
Links Einspeisung	GB 11-3	GB 11-2	GB 11-1
Rechts Einspeisung	GB 12-3	GB 12-2	GB 12-1
Einspeisung Mitte	GB 14-3	GB 14-2	GB 14-1
Verbinder	GB 21-3	GB 21-2	GB 21-1
L-Form Verbinder	GB 34-3	GB 34-2	GB 34-1
L-Form Verbinder	GB 35-3	GB 35-2	GB 35-1
T-Form Verbinder	GB 36-3	GB 36-2	GB 36-1
T-Form Verbinder	GB 37-3	GB 37-2	GB 37-1
T-Form Verbinder	GB 39-3	GB 39-2	GB 39-1
T-Form Verbinder	GB 40-3	GB 40-2	GB 40-1
X-Form Verbinder	GB 38-3	GB 38-2	GB 38-1
Flexibler Verbinder 60–360°	GB 24-3	GB 24-2	GB 24-1
Endkappe	GB 41-3	GB 41-2	GB 41-1

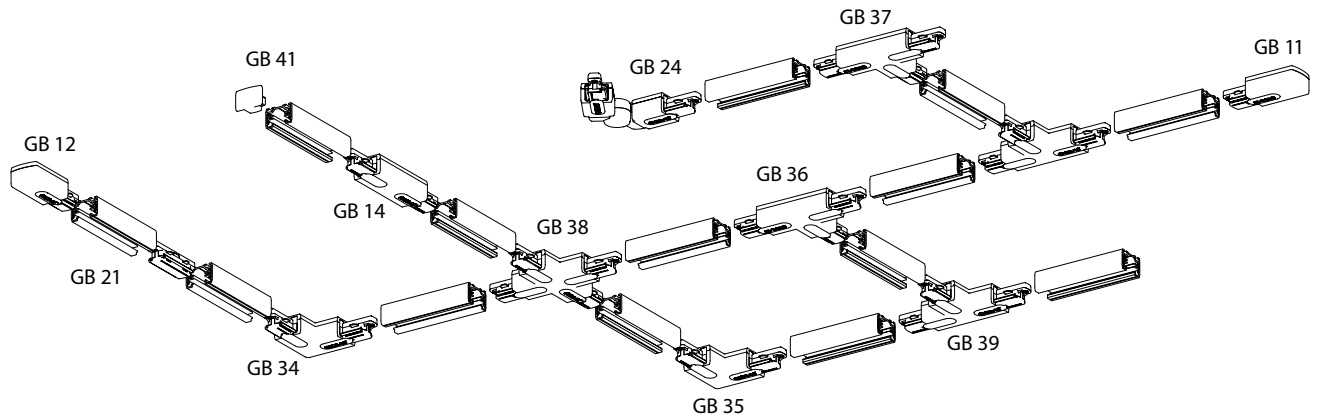
**Adapter 1-Phase – 230V**

weiss matt
 schwarz
 Grau
 Aluminium

	6A – 5kg	GB 66-3	GB 66-2	GB 66-1	—
	M10 Alu Drehnippel H10mm	GA 57/10-3	GA 57/10-2	GA 57/10-1	GA 57/10-1
	Kunststoff Nippel mit Zugentlastung	GB 510-3	GB 510-2	GB 510-1	—
	10A – 10kg	GB 67-3	GB 67-2	GB 67-1	—
	M10 Alu Nippel H8mm	—	—	—	XTS 58/8-9
	M10 Alu Drehnippel H8mm	—	—	—	XTSA 57/8-9
	M10 Alu Drehnippel H12mm	—	XTSA 57/12-2	—	XTSA 57/12-9
	Kunststoff Zugentlastung Fur M10 Gewinde	XTSA 510-3	XTSA 510-2	XTSA 510-1	—
	M10 Mutter	—	—	—	GAM 10-9
	Drehbarer Metall Nippel mit M10 Gewinde	—	—	—	XTSA 63-9

Zubehör

weiss matt
 schwarz
 Grau
 Aluminium

	Deckenklammer M6	—	—	—	GBS 33-9
	Kupplungsverstärkung	—	—	—	GBS 18-9
	1m Deckenpendel	SP R6-3	SP R6-2	—	—
	1.5m Seilpendel M6	SPW 1-3	SPW 1-2	SPW 1-1	—
	Kunststoff Hackenhalter	GBA 14-3	GBA 14-2	GBA 14-1	—
	2mm Stahlhacken	—	—	XTAK 11-1	—

GLOBAL TRACK BASE 3-Phasen Stromschiene

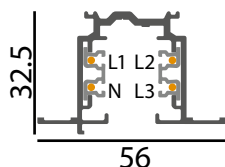
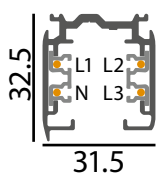
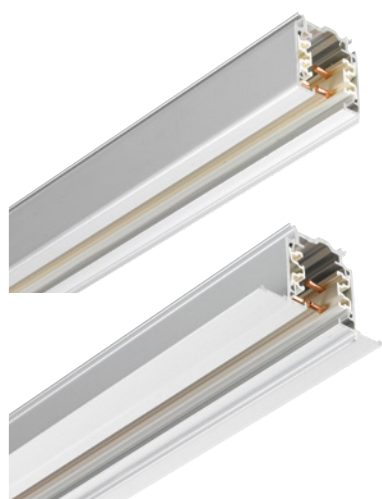

3-Phase Aufbau Stromschiene

weiss matt schwarz Aluminium

L=1m	XTS 4100-3	XTS 4100-2	XTS 4100-1
L=2m	XTS 4200-3	XTS 4200-2	XTS 4200-1
L=3m	XTS 4300-3	XTS 4300-2	XTS 4300-1

3-Phase Einbau Stromschiene

weiss matt schwarz Aluminium



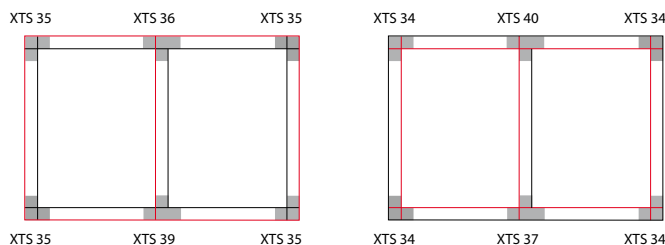
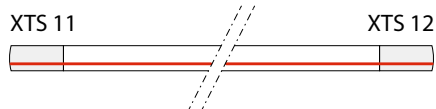



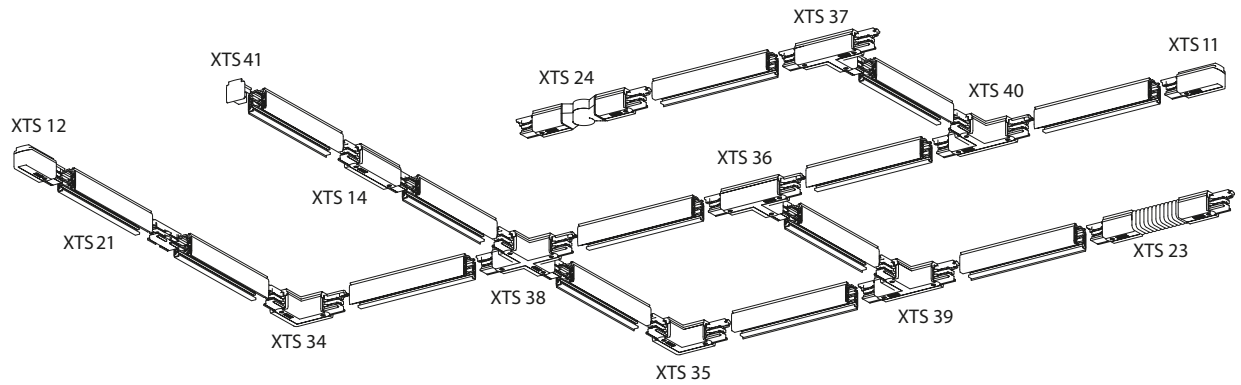

L=1m	XTSF 4100-3	XTSF 4100-2	XTSF 4100-1
L=2m	XTSF 4200-3	XTSF 4200-2	XTSF 4200-1
L=3m	XTSF 4300-3	XTSF 4300-2	XTSF 4300-1













weiss matt schwarz Aluminium

		Links Einspeisung 3-Phase	XTS 11-3	XTS 11-2	XTS 11-1
		Rechts Einspeisung 3-Phase	XTS 12-3	XTS 12-2	XTS 12-1
		Einspeisung 3-Phase Mitte	XTS 14-3	XTS 14-2	XTS 14-1
		Verbinder	XTS 21-3	XTS 21-2	XTS 21-1
		L-Form Verbinder	XTS 34-3	XTS 34-2	XTS 34-1
		L-Form Verbinder	XTS 35-3	XTS 35-2	XTS 35-1
		T-Form Verbinder	XTS 36-3	XTS 36-2	XTS 36-1
		T-Form Verbinder	XTS 37-3	XTS 37-2	XTS 37-1
		T-Form Verbinder	XTS 39-3	XTS 39-2	XTS 39-1
		T-Form Verbinder	XTS 40-3	XTS 40-2	XTS 40-1
		X-Form Verbinder	XTS 38-3	XTS 38-2	XTS 38-1
		Flexibler Verbinder 60–360°	XTS 24-3	XTS 24-2	XTS 24-1
		Endkappe	XTS 41-3	XTS 41-2	XTS 41-1

**Adapter 3-Phasen – 230V**
 weiss matt schwarz Grau Aluminium

	6A – 5kg	GA69-3	GA69-2	GA69-1	—
	10A – 10kg	GA68-3	GA68-2	GA68-1	—
	Kunststoff Nippel mit Zugentlastung	GB 510-3	GB 510-2	GB 510-1	—
	M10 Alu Nippel H8mm	—	—	—	XTS 58/8-9
	M10 Alu Drehnippel H8mm	—	—	—	XTSA 57/8-9
	M10 Alu Drehnippel H12mm	—	XTSA 57/12-2	—	XTSA 57/12-9
	Kunststoff Zugentlastung Fur M10 Gewinde	XTSA 510-3	XTSA 510-2	XTSA 510-1	—
	M10 Mutter	—	—	—	GAM 10-9
	Drehbarer Metall Nippel mit M10 Gewinde	—	—	—	XTSA 63-9



Zubehör
 weiss matt schwarz Grau Aluminium

	Einbauring	XSTA 71-3	XSTA 71-2	XSTA 71-1	
	Deckendose	GA 70-3	GA 70-2	GA 70-1	
	Kunststoff Hackenhalter	XTAK 142-3	XTAK 142-2	XTAK 142-1	
	2mm Stahlhacken	—	—	XTAK 11-1	—
	Deckenklammer	SKB 12-3	SKB 12-2	SKB 12-1	
	Aufhängebrücke	SKB 18-3	—	SKB 18-1	
	Flügelplatte	XTSF 10-3	XTSF 10-2	—	
	Abdeckstreifen 3m	XTSP 11-3	—	—	
	Seilset 1.5m	SPWFG-3/1.5	SPWFG-2/1.5	SPWFG-1/1.5	
	Seilset 3m	SPWFG-3/3	SPWFG-2/3	SPWFG-1/3	
	Leiterbiegeschlüssel			XTSV 12	

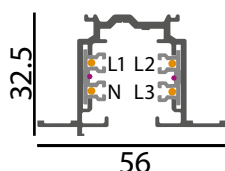
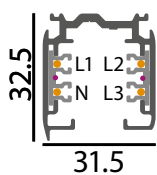

GLOBAL TRACK Pulse Stromschiene















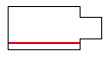

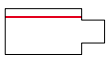



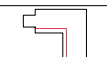



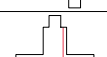

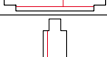

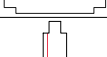

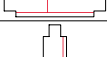
3-Phase DALI Aufbau Stromschiene

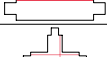
	 weiss matt	 schwarz	 Aluminium
L=1m	XTSC 6100-3	XTSC 6100-2	XTSC 6100-1
L=2m	XTSC 6200-3	XTSC 6200-2	XTSC 6200-1
L=3m	XTSC 6300-3	XTSC 6300-2	XTSC 6300-1

3-Phase DALI Einbau Stromschiene

	 weiss matt	 schwarz	 Aluminium
L=1m	XTSCF 6100-3	XTSCF 6100-2	XTSCF 6100-1
L=2m	XTSCF 6200-3	XTSCF 6200-2	XTSCF 6200-1
L=3m	XTSCF 6300-3	XTSCF 6300-2	XTSCF 6300-1

	 weiss matt	 schwarz	 Aluminium	
  Links Einspeisung 3-Phase	XTSC 611-3	XTSC 611-2	XTSC 611-1	
  Rechts Einspeisung 3-Phase	XTSC 612-3	XTSC 612-2	XTSC 612-1	
 Einspeisung 3-Phase Mitte	XTSC 614-3	XTSC 614-2	XTSC 614-1	
 Verbinder	XTSC 621-3	XTSC 621-2	XTSC 621-1	
  L-Form Verbinder	XTSC 634-3	XTSC 634-2	XTSC 634-1	
  L-Form Verbinder	XTSC 635-3	XTSC 635-2	XTSC 635-1	
  T-Form Verbinder	XTSC 636-3	XTSC 636-2	XTSC 636-1	
  T-Form Verbinder	XTSC 637-3	XTSC 637-2	XTSC 637-1	
  T-Form Verbinder	XTSC 639-3	XTSC 639-2	XTSC 639-1	
  T-Form Verbinder	XTSC 640-3	XTSC 640-2	XTSC 640-1	
  X-Form Verbinder	XTSC 638-3	XTSC 638-2	XTSC 638-1	
 Flexibler Verbinder 60–360°	XTSC 623-3	XTSC 623-2	XTSC 623-1	
 Endkappe	XTS 41-3	XTS 41-2	XTS 41-1	4.00 CHF
 Deckenklammer	SKB 12-3	SKB 12-2	SKB 12-1	
 Aufhängebrücke	SKB 18-3	—	SKB 18-1	
 Flügelplatte	XTSF 610-3	XTSF 610-2	XTSF 610-1	
 Abdeckstreifen 3m	XTSP 11-3	XTSP 11-2	—	

Multi LED Konverter für Global 3Phasen Schiene **GA-017 Super**

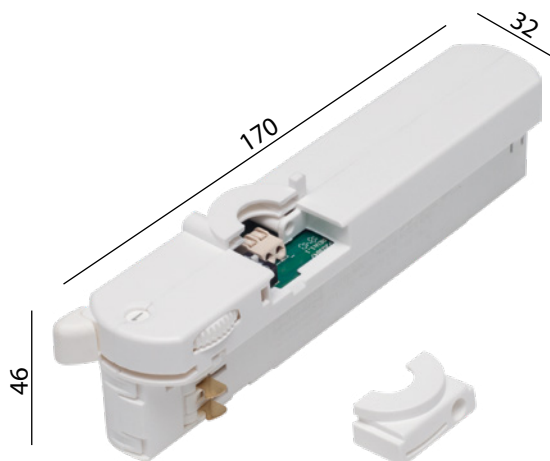

Schutzart	IP 20
Primärseitig	200-240V AC 50/60Hz
Umgebungstemp.	0 – 35°C
Messpunkt tc	85°C
Dimmbar	—
Abmessungen	170 × 32 × 46mm

SEC	Pout	1	2	3	4
200mA	8W	—	—	—	—
250mA	10W	—	—	—	—
300mA	12W	—	—	—	—
350mA	14W	—	—	—	on
400mA	16W	—	—	on	—
450mA	18W	—	—	on	on
500mA	20W	—	on	—	—
550mA	22W	—	on	—	on
600mA	24W	—	on	on	—
650mA	26W	—	on	on	on
700mA	28W	on	—	—	—
750mA	30W	on	—	—	on



127991W	<input type="checkbox"/> weiss	200...750mA	8...30W
127991B	<input type="checkbox"/> schwarz	200...750mA	8...30W
127991G	<input type="checkbox"/> grau	200...750mA	8...30W

Multi LED Konverter für Global Pulse Schiene **GAC-616 Mini DALI**

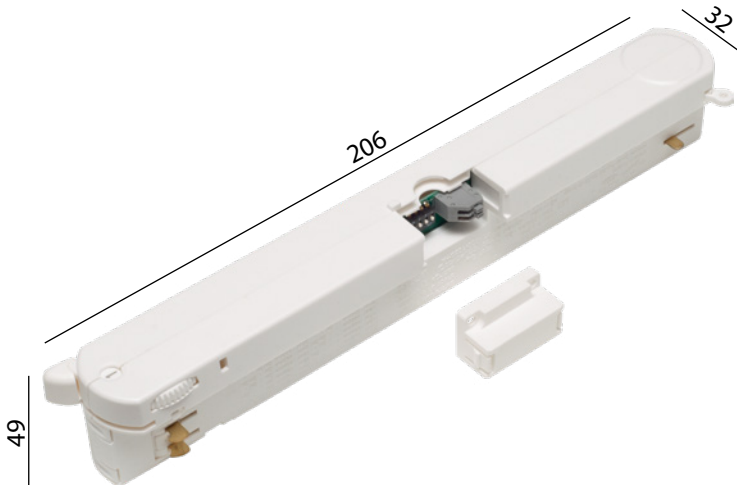

Schutzart	IP 20
Primärseitig	200-240V AC 50/60Hz
Umgebungstemp.	0 – 35°C
Messpunkt tc	85°C
Dimmbar	—
Abmessungen	206 × 32 × 49mm

SEC	Pout	1	2	3	4
300mA	12.6W	—	—	—	—
350mA	14.7W	—	—	—	on
400mA	16.8W	—	—	on	—
450mA	18.9W	—	—	on	on
500mA	21W	—	on	—	—
550mA	23W	—	on	—	on
600mA	25.2W	—	on	on	—
650mA	27.3W	—	on	on	on
700mA	29.4W	on	—	—	—
750mA	31.5W	on	—	—	on
800mA	33.6W	on	—	on	—
850mA	34W	on	—	on	on
900mA	36W	on	on	—	—
950mA	38W	on	on	—	on
1000mA	40W	on	on	on	—
1050mA	40W	on	on	on	on



127945W	weiss	300...1050mA	12.6...40W
127945B	schwarz	300...1050mA	12.6...40W
127945G	grau	300...1050mA	12.6...40W

CASAMBI Multi LED Konverter für 3Phasen Schiene

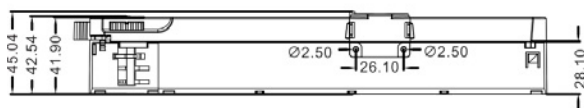
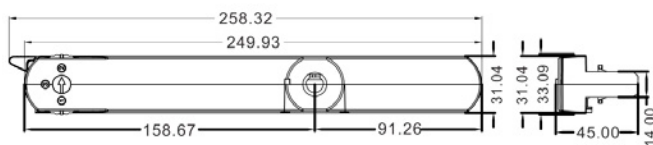
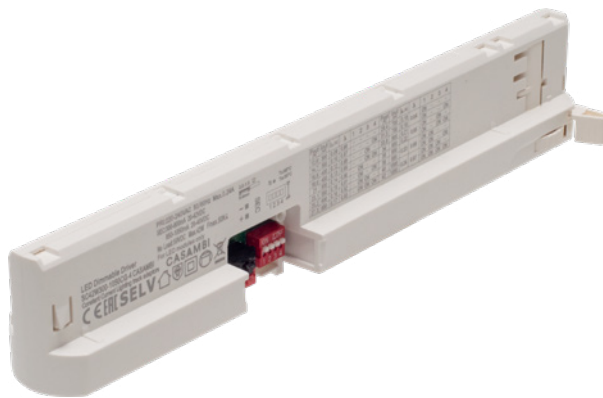

Schutzart	IP 20
Primärseitig	220-240V AC 50/60Hz
Umgebungstemp.	-20 – 35°C
Messpunkt tc	85°C
Dimmbar	CASAMBI
max. Last	5kg
Abmessungen	122 × 59 × 43mm

SEC	Pout	Dip-Schalter			
		1	2	3	4
300mA	12.6W	—	—	—	—
350mA	14.7W	—	—	—	on
400mA	16.8W	—	—	on	—
450mA	18.9W	—	—	on	on
500mA	21W	—	on	—	—
550mA	23.1W	—	on	—	on
600mA	25.2W	—	on	on	—
650mA	27.3W	—	on	on	on
700mA	29.4W	on	—	—	—
750mA	31.5W	on	—	—	on
800mA	33.6W	on	—	on	v
850mA	34W	on	—	on	on
900mA	36W	on	on	—	—
950mA	38W	on	on	—	on
1000mA	40W	on	on	on	—
1050mA	42W	on	on	on	on



GAC-616 CS -00	weiss	300...1050mA	12.6...42W
GAC-616 CS -02	schwarz	300...1050mA	12.6...42W

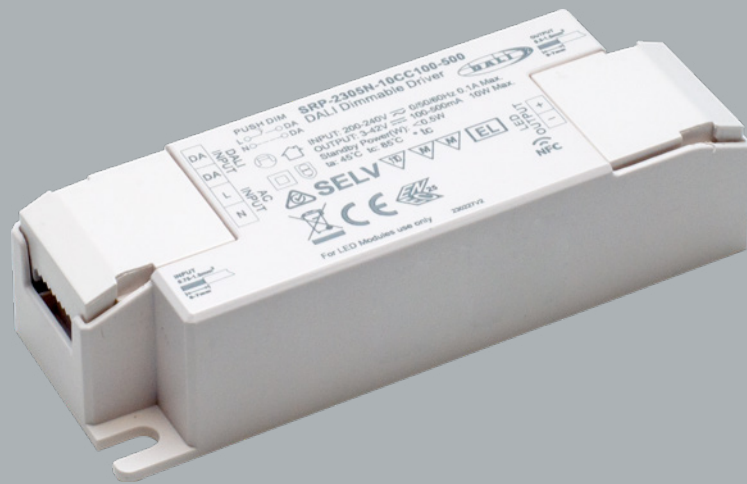

Konverter & Zubehör



152 Konverter
DALI dimmbar



160 Konverter
Phasenabschnitt dimmbar



162 Konverter
Nicht dimmbar – An / Aus

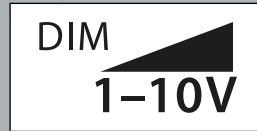

166 Konverter
1-10V dimmbar



168
DALI Steuerung



169 Dimmer
DALI → Phasenabschnitt



170
230V AC Dimmer



172 HaloX-100
Einbaugehäuse



173 HaloX-180
Einbaugehäuse



174 Lumina
Einbaugehäuse



174
Firestop-Boxen



175 HaloX-100
Kabelverbinder



175 HaloX-100
Kabelkupplung

DALI-2 DT6 LED Konverter 3W



Schutzart	IP 20
Primärseitig	110-240V AC 50/60Hz
Umgebungstemp.	-20 – 45°C
Messpunkt tc	75°C
Dimmbar	DALI DT6
Abmessungen	59 × 33 × 15mm

73154-350	350mA	3W
73154-500	500mA	3W
73154-700	700mA	3W

350mA DALI LED Konverter



Schutzart	IP 20
Primärseitig	200-240V AC 50/60Hz
Umgebungstemp.	- 50°C
Messpunkt tc	75°C
Dimmbar	DALI
Abmessungen	ø58 × 28mm

80799	350mA	1-8W
-------	-------	------

Alle Preise excl. MwSt. und VRG.

500mA DALI-2 / Push DIM LED Konverter

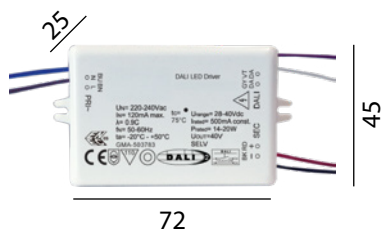

Schutzart	IP 20
Primärseitig	100-240V AC 50/60Hz
Umgebungstemp.	-20 – 40°C
Messpunkt tc	75°C
Dimmbar	DALI / Push DIM
Abmessungen	72 × 45 × 25mm

730070-20	500mA	14-20W
-----------	-------	--------

500mA DALI / Push DIM LED Konverter

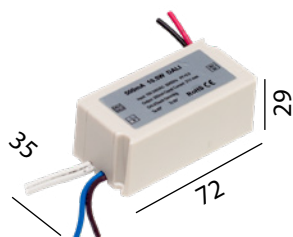

Schutzart	IP 20
Primärseitig	100-240V AC 50/60Hz
Umgebungstemp.	-20 – 40°C
Messpunkt tc	95°C
Dimmbar	DALI / Push DIM
Abmessungen	72 × 35 × 29mm

Impuls: an / aus Halten: dimmen

Reset durch doppelten Impuls

730070	500mA	3-10.5W
--------	-------	---------

Multi / Push Dim LED Mini Konverter

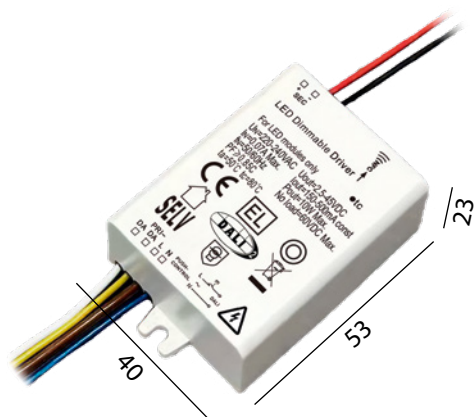

Schutzart	IP 20
Primärseitig	220-240V AC 50/60Hz
Umgebungstemp.	-25 – 50°C
Messpunkt tc	80°C
Dimmbar	DALI (2mA) / Push DIM
Abmessungen	53 × 40 × 23mm

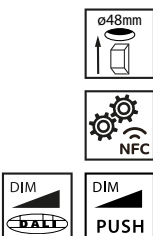

SEC	Pout	NFC)))
Konstantstrom		
150mA	6.75W	In 1mA-Schritten einstellbar zwischen 150 – 500mA mit NFC (Smatphone oder Panel)
200mA	11.25W	
250mA	10W	
300mA	9.9W	
350mA	9.8W	
450mA	10W	
500mA	11W	

730040-11 500mA (voreingestellt) 11W

Multi / Push Dim LED Mini Konverter

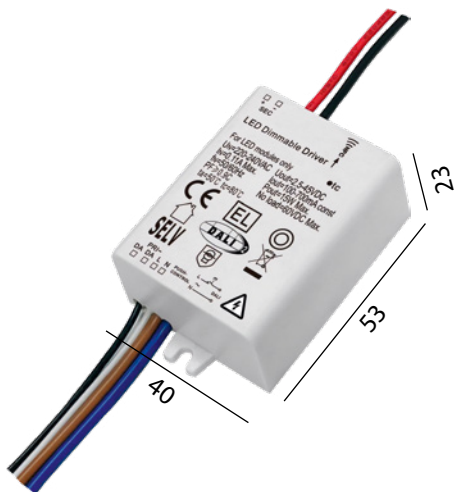

Schutzart	IP 20
Primärseitig	220-240V AC 50/60Hz
Umgebungstemp.	-25 – 50°C
Messpunkt tc	80°C
Dimmbar	DALI (2mA) / Push DIM
Abmessungen	53 × 40 × 23mm

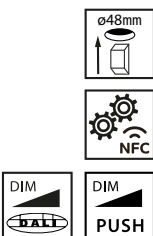

SEC	Pout	NFC)))
Konstantstrom		
100mA	4.5W	In 1mA-Schritten einstellbar zwischen 100 – 700mA mit NFC (Smatphone oder Panel)
200mA	9W	
350mA	14.7W	
400mA	15.2W	
500mA	15W	
600mA	15W	
700mA	15.4W	

730040-15 500mA (voreingestellt) 15W

Multi DALI LED Konverter



Schutzart	IP 20
Primärseitig	100-240V AC 50/60Hz
Umgebungstemp.	-30 – 50°C
Messpunkt tc	75°C
Dimmbar	DALI
Abmessungen	135 × 30 × 20mm

SEC	Pout	Dip-Schalter		
		1	2	4
Konstantstrom				
350mA	8.4W	–	–	–
400mA	9.6W	–	–	on
450mA	10.8W	–	on	–
500mA	12W	–	on	on
550mA	12W	on	–	–
600mA	12W	on	–	on
650mA	12W	on	on	–
700mA	12W	on	on	on



730128

350...700mA

8.4...12W

Multi DALI / Push Dim LED Konverter

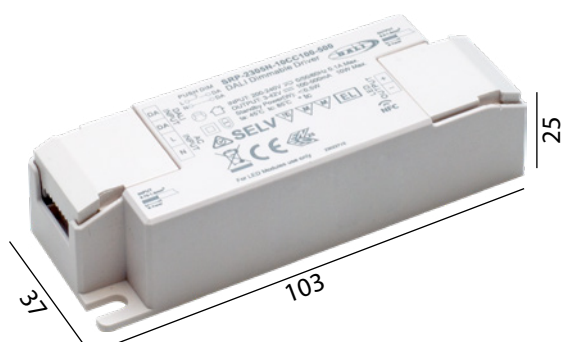

Schutzart	IP 20
Primärseitig	220-240V AC 50/60Hz
Umgebungstemp.	-25 – 45°C
Messpunkt tc	85°C
Dimmbar	DALI (2mA) / Push DIM
Abmessungen	103 × 37 × 25mm

SEC	Pout	NFC)))
Konstantstrom		
100mA	4.2W	In 1mA-Schritten einstellbar zwischen 100 – 500mA mit NFC (Smatphone oder Panel)
200mA	8.4W	
350mA	11W	
500mA	10W	

Push Dim	Dücken	Halten	2 × Drücken
DT6	an / aus	Dimmen	—
DT8 TW	an / aus	• Dimmen • Farbtemperatur	Wechsel zwischen Dimmen und Farbtemperatur

Vorverkabelt, inklusive Klemmen für N, L und DALI

730115-500 VK

DT6 - 500mA (voreingestellt)

10W

730115-DT8

DT8 TW - 500mA (voreingestellt)

10W

Multi / Push Dim LED Konverter

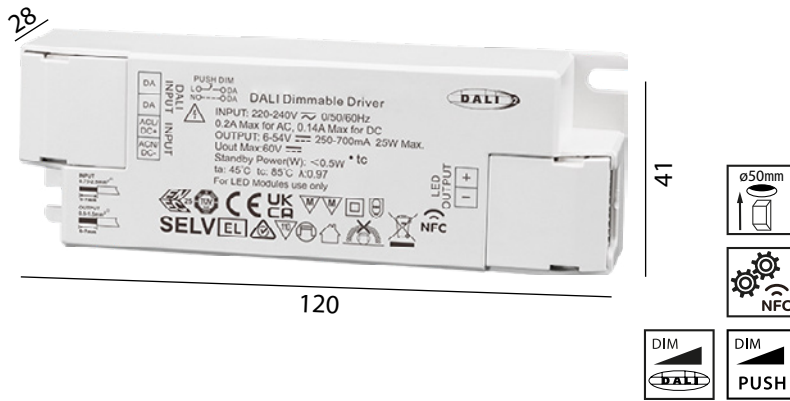

Schutzart	IP 20
Primärseitig	220-240V AC 50/60Hz
Umgebungstemp.	-25 – 45°C
Messpunkt tc	85°C
Dimmbar	DALI (2mA) / Push DIM
Abmessungen	120 × 41 × 28mm

SEC	Pout	NFC)))
250mA	14.5W	In 1mA-Schritten einstellbar zwischen 250 – 700mA mit NFC (Smatphone oder Panel)
350mA	20W	
500mA	25W	
700mA	22W	

Push Dim	Dücken	Halten	2 × Drücken
DT6	an / aus	Dimmen	—
DT8 TW	an / aus	• Dimmen • Farbtemperatur	Wechsel zwischen Dimmen und Farbtemperatur

Vorverkabelt, inklusive Klemmen für N, L und DALI

730125-DT6	DT6 - 500mA (voreingestellt)	25W
730125-DT8	DT8 TW - 500mA (voreingestellt)	25W

Multi / Push Dim LED Konverter

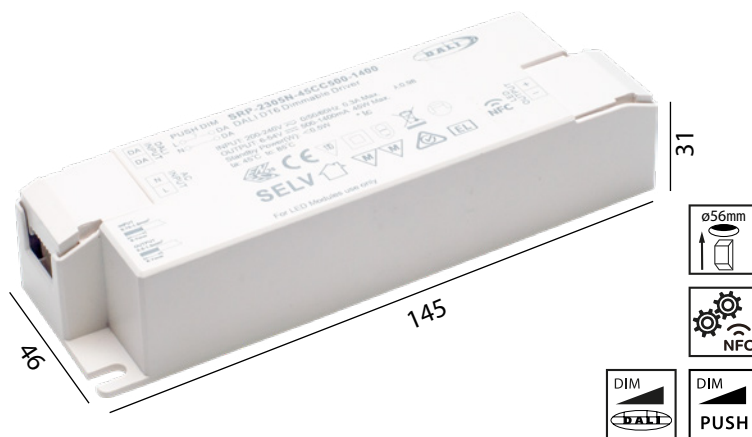

Schutzart	IP 20
Primärseitig	220-240V AC 50/60Hz
Umgebungstemp.	-25 – 45°C
Messpunkt tc	85°C
Dimmbar	DALI / Push DIM
Abmessungen	145 × 46 × 31mm

SEC	Pout	NFC)))
500mA	29W	In 1mA-Schritten einstellbar zwischen 500 – 1400mA mit NFC (Smatphone oder Panel)
700mA	41W	
900mA	48W	
1200mA	51W	
1400mA	45W	

Push Dim	Dücken	Halten	2 × Drücken
DT6	an / aus	Dimmen	—

Vorverkabelt, inklusive Klemmen für N, L und DALI

730120 VK	700mA (voreingestellt)	41W
------------------	-------------------------------	------------

Multi LED Konverter MINI JOLLY LC

(für kleine Ströme)



Schutzart	IP 20
Primärseitig	110-240V AC 50/60Hz
Umgebungstemp.	-25 – 45°C
Messpunkt tc	75°C
Dimmbar	DALI
Abmessungen	111 × 52 × 22mm

SEC Pout	100mA 5.3W	140mA 7.5W	180mA 9.5W	220W 12W	260W 14W	300mA 16W	340mA 18W	380mA 20W	24V DC 9W
----------	---------------	---------------	---------------	-------------	-------------	--------------	--------------	--------------	--------------

730092 **100...380mA** **24V DC** **5.3...20W**

Multi LED Konverter MINI JOLLY



Schutzart	IP 20
Primärseitig	110-240V AC 50/60Hz
Umgebungstemp.	-25 – 45°C
Messpunkt tc	75°C
Dimmbar	DALI
Abmessungen	111 × 52 × 22mm

SEC Pout	150mA 8.1W	200mA 10.8W	250mA 13.5W	300mA 16.2W	350mA 18.9W	400mA 21.6W	450mA 24.3W	500mA 25W	550mA 25W
	600mA 25W	650mA 25W	700mA 25W	750mA 25W	800mA 25W	850mA 25W	900mA 25W	24V DC 22W	

730040-25 **150...900mA** **24V DC** **8.1...25W**

350 / 500 / 700 / 1000mA LED Konverter



Schutzart	IP 20
Primärseitig	220-230V AC 50/60Hz
Umgebungstemp.	-25 – 50°C
Messpunkt tc	80°C
Dimmbar	DALI
Abmessungen	180 × 32 × 32mm

730058	350mA	5-17W
730059	500mA	8-24W
730054	700mA	10-30W
730053	1000mA	15-30W

 Solange der Vorrat reicht

Multi LED Konverter



Schutzart	IP 20
Primärseitig	220-240V AC 50/60Hz
Umgebungstemp.	-20 – 45°C
Messpunkt tc	75°C
Dimmbar	DALI / Push DIM
Abmessungen	150 × 52 × 28mm

SEC	350mA	500mA	700mA	900mA	12V DC	24V DC
Pout	15W	20W	20W	20W	10W	20W

730060

350...900mA

12...24V DC

10...20W

Solange der Vorrat reicht

Multi LED Konverter



Schutzart	IP 20
Primärseitig	220-240V AC 50/60Hz
Umgebungstemp.	-20 – 45°C
Messpunkt tc	80°C
Dimmbar	DALI / Push DIM
Abmessungen	124 × 79.2 × 30mm

SEC	350mA	500mA	700mA	900mA	12V DC	24V DC
Pout	18W	26W	36W	40W	10.5W	21.5W

730061

350...900mA

12...24V DC

10.5...40W

Solange der Vorrat reicht



Stromgeführte LED niemals parallel schalten!!



LED immer ohne Stromzufuhr anschliessen!!

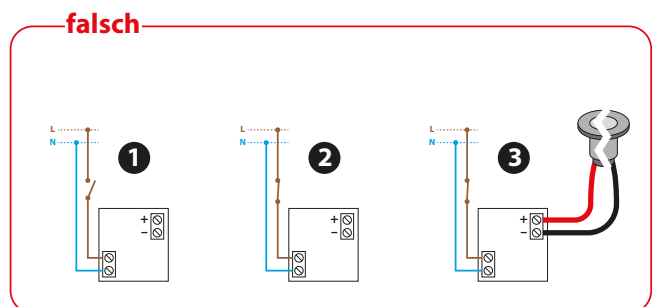
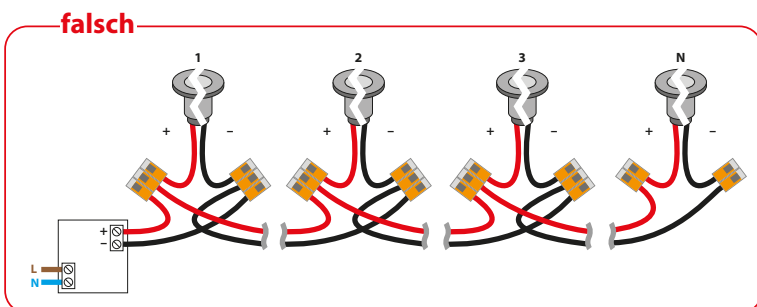
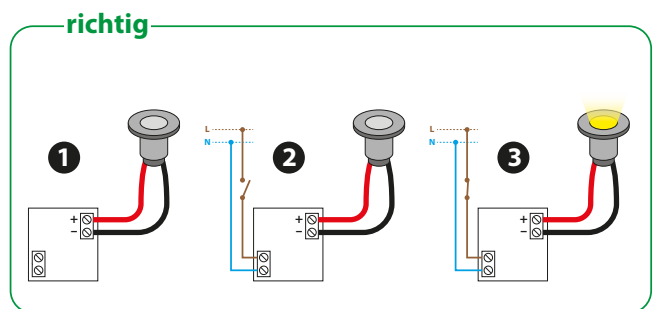
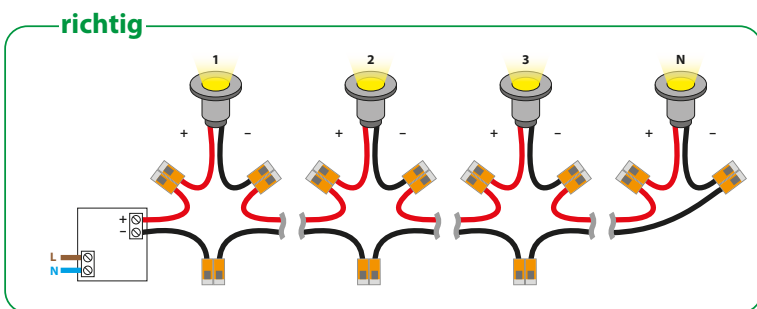

Multi DALI / Push DIM LED Konverter PRO BI



Schutzart	IP 20
Primärseitig	220-240V AC 50/60Hz
Umgebungstemp.	-25 – 45°C
Messpunkt tc	80°C
Dimmbar	DALI / Push DIM
Abmessungen	97 × 42 × 30mm



SEC	300mA	350mA	400mA	450mA	500mA	550mA	600mA	650mA
Pout	16W	18W	21W	24W	27W	29W	32W	35W
SEC	700mA	750mA	800mA	850mA	900mA	950mA	1000mA	1050mA
Pout	38W	38W	38W	38W	38W	38W	38W	38W

730093

300...1050mA

16...38W

Multi DALI / Push Dim LED Konverter PRO



Schutzart	IP 20
Primärseitig	220-240V AC 50/60Hz
Umgebungstemp.	-25 – 45°C
Messpunkt tc	80°C
Dimmbar	DALI / Push DIM
Abmessungen	130 × 42 × 30mm



SEC	300mA	350mA	400mA	450mA	500mA	550mA	600mA	650mA
Pout	16W	18W	21W	24W	27W	29W	32W	35W
SEC	700mA	750mA	800mA	850mA	900mA	950mA	1000mA	1050mA
Pout	38W	38W	38W	38W	38W	38W	38W	38W

730094

300...1050mA

16...38W

Multi DALI LED Konverter JOLLY

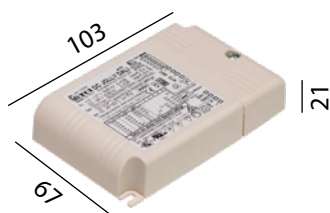

Schutzart	IP 20
Primärseitig	200-240V AC 50/60Hz
Umgebungstemp.	-25 – 50°C
Messpunkt tc	75°C
Dimmbar	DALI
Abmessungen	103 × 67 × 21mm



SEC	350mA	500mA	550mA	700mA	10V DC	12V DC	24V DC
Pout	17W	24W	25W	32W	9W	10W	20W

730041

350...700mA

10...24V DC

9...32W

Multi / 1-10V / Push DIM LED Konverter **MAXI JOLLY SV DALI**

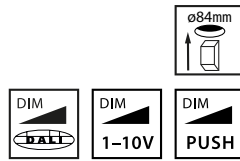
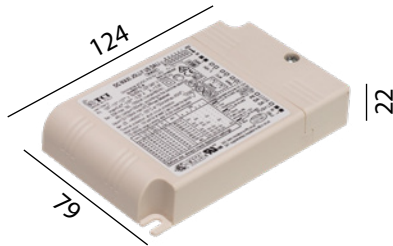

Schutzart	IP 20
Primärseitig	220-240V AC 50/60Hz
Umgebungstemp.	-25 – 50°C
Messpunkt tc	90°C
Dimmbar	DALI / 1–10V / Push DIM
Abmessungen	124 × 79 × 22mm

SEC	350mA	400mA	450mA	500mA	550mA	600mA	650mA	700mA	750mA
Pout	18.5W	21W	23.5W	26.5W	29W	31.5W	34.5W	37W	39.5W
SEC	800mA	850mA	900mA	950mA	1000mA	1050mA	1100mA	1150mA	1200mA
Pout	42W	45W	47.5W	50W	50W	50W	50W	50W	50W

730095

350...1200mA

18.5...50W

Multi / 1-10V / Push DIM LED Konverter **MAXI JOLLY HV** (mit höherer Leistung)

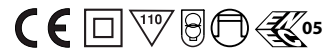
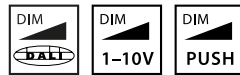
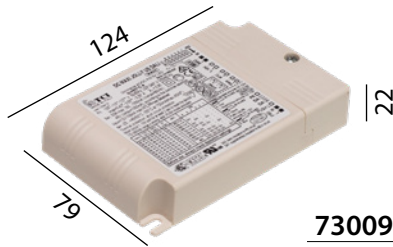

Schutzart	IP 20
Primärseitig	220-240V AC 50/60Hz
Umgebungstemp.	-25 – 50°C
Messpunkt tc	90°C
Dimmbar	DALI / 1–10V / Push DIM
Abmessungen	124 × 79 × 22mm

SEC	250mA	300mA	350mA	400mA	450mA	500mA	550mA	600mA	650mA	700mA
Pout	28W	34W	39W	45W	50W	56W	60W	60W	60W	60W

730091

250...700mA

28...60W

Multi / 1-10V / Push DIM LED Konverter **MAXI JOLLY SLIM HV** (mit höherer Leistung)

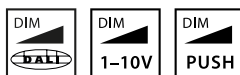

Schutzart	IP 20
Primärseitig	220-240V AC 50/60Hz
Umgebungstemp.	-25 – 45°C
Messpunkt tc	70/80°C
Dimmbar	DALI / 1–10V / Push DIM
Abmessungen	280 × 40 × 22mm

SEC	350mA	500mA	550mA	700mA	850mA	900mA	1050mA	58V DC
Pout	25W	35W	39W	50W	60W	60W	60W	60W

730056

250...700mA

58V DC

30...60W

350 / 500 / 700mA LED Konverter

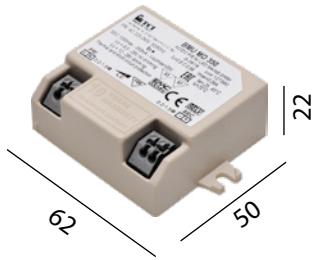

Phasenabschnitt dimmbar mit Feller LED Universaldimmer 40200.LED



Schutzart	IP 20
Primärseitig	220-240V AC 50/60Hz
Umgebungstemp.	-20 – 45°C
Messpunkt tc	70°C
Dimmbar	mit Phasenabschnittdimmer [R C]
Abmessungen	62 × 50 × 22mm

730096	350mA	4.2-9.8W
730097	500mA	4.5-10W
730098	700mA	4.2-9.8W

500mA LED Konverter

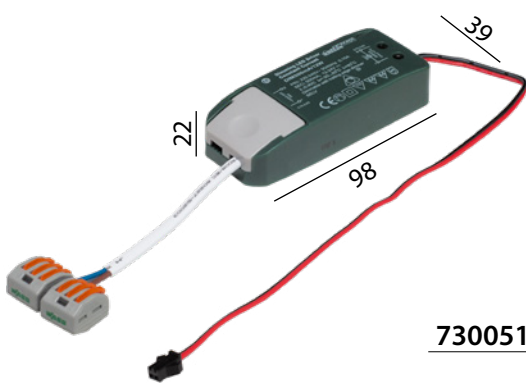

Phasenabschnitt dimmbar mit Feller LED Universaldimmer 40200.LED



Schutzart	IP 20
Primärseitig	200-240V AC 50/60Hz
Umgebungstemp.	-25 – 50°C
Messpunkt tc	80°C
Dimmbar	mit Phasenabschnittdimmer [R C]
Abmessungen	98 × 39 × 22mm

Vorverkabelt, inklusive WAGO Klemmen

730051	500mA	6-12W
--------	-------	-------

Solange der Vorrat reicht

350 / 500mA LED Konverter

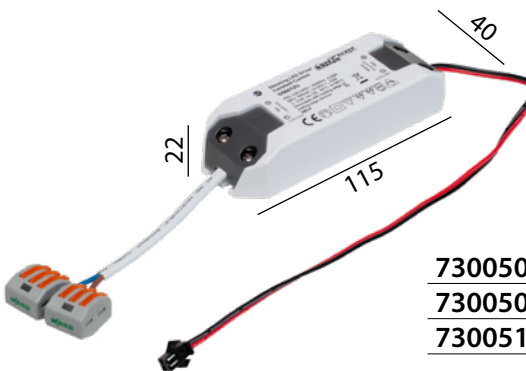

Phasenabschnitt dimmbar mit Feller LED Universaldimmer 40200.LED



Schutzart	IP 20
Primärseitig	220-240V AC 50/60Hz
Umgebungstemp.	-20 – 45/50°C
Messpunkt tc	80/90°C
Dimmbar	mit Phasenabschnittdimmer [R C]
Abmessungen	115 × 40 × 22mm

Vorverkabelt, inklusive WAGO Klemmen

730050-09U	350mA	4-9W
730050-12U	350mA	7-12W
730051-12U	500mA	6-12W

350 / 450mA LED Konverter

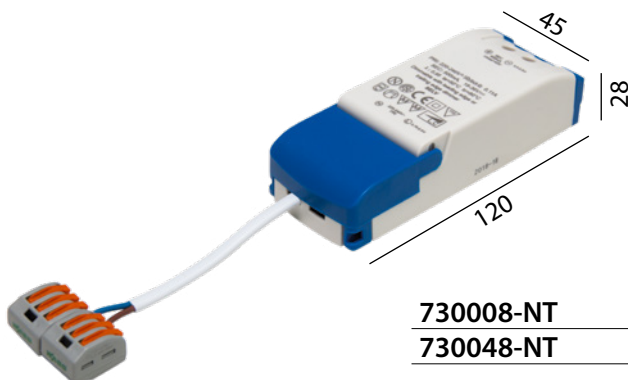

Schutzart	IP 20
Primärseitig	220-240V AC 50/60Hz
Umgebungstemp.	-20 – 50°C
Messpunkt tc	80°C
Dimmbar	mit Phasen- und Phasenabschnittdimmer [L C]
Abmessungen	120 × 45 × 28mm

Vorverkabelt, inklusive WAGO Klemmen

730008-NT	350mA	9-18W
730048-NT	450mA	9-18W

350 / 500 / 700mA LED Konverter

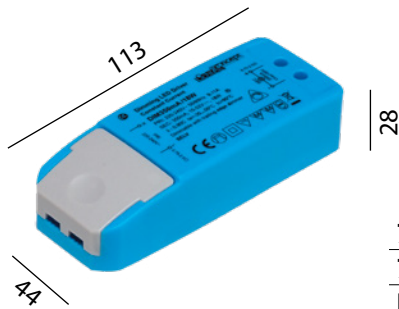

Phasenabschnitt dimmbar mit
Feller LED Universaldimmer
40200.LED



Schutzart	IP 20
Primärseitig	220-240V AC 50/60Hz
Umgebungstemp.	-20 – 50°C
Messpunkt tc	90°C
Dimmbar	mit Phasenabschnittdimmer [R C]
Abmessungen	113 × 44 × 28mm

730008	350mA	5-18W
730048	500mA	5-18W
RN 1408	700mA	5-18W

Solange der Vorrat reicht

500mA LED Konverter IP65

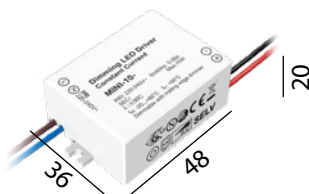

Phasenabschnitt dimmbar mit
Feller LED Universaldimmer
40200.LED



Schutzart	IP 65
Primärseitig	220-240V AC 50/60Hz
Umgebungstemp.	-20 – 60°C
Messpunkt tc	90°C
Dimmbar	mit Phasenabschnittdimmer [R C]
Abmessungen	127 × 44 × 28mm

73144-500	500mA	10W
------------------	--------------	------------

Multi / Push DIM LED Konverter

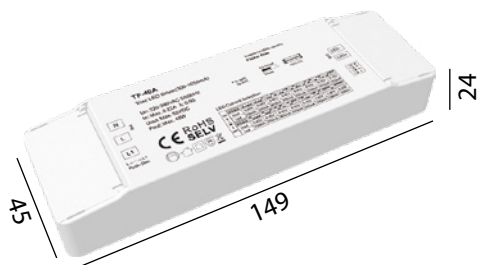

Schutzart	IP 20
Primärseitig	220-240V AC 50/60Hz
Umgebungstemp.	-20 – 45°C
Messpunkt tc	90°C
Dimmbar	Phasenabschnitt [R C] / Push DIM
Abmessungen	149 × 45 × 24mm

SEC	300mA	350mA	400mA	450mA	500mA	550mA	600mA	650mA
Pout	13.5W	15.75W	18W	20.25W	22.5W	24.75W	27W	29.25W
SEC	700mA	750mA	800mA	850mA	900mA	950mA	1000mA	1050mA
Pout	31.5W	33.75W	36W	38.25W	37.8W	39.9W	40W	39.9W

730039-02	300...1050mA	13.5...40W
------------------	---------------------	-------------------

350mA LED Konverter

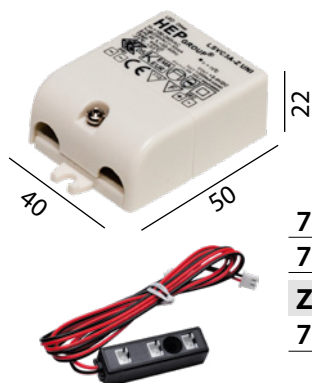

Schutzart	IP 20
Primärseitig	100-240V AC 50/60Hz
Umgebungstemp.	-20 – 50°C
Messpunkt tc	75°C
Dimmbar	—
Abmessungen	50 × 40 × 22mm

73003-KL	350mA	1-3W mit Schraubklemme
73003-S	350mA	1-3W mit Stecker
Zubehör		
72001	Verteiler 3-fach	

350mA LED Konverter



Schutzart	IP 20
Primärseitig	95-240V AC 50/60Hz
Umgebungstemp.	60°C
Messpunkt tc	80°C
Dimmbar	—
Abmessungen	40 × 42 × 21mm

PTDCC/3/350/N	350mA	1-3W mit Schraubklemme
----------------------	--------------	-------------------------------

700mA LED Konverter

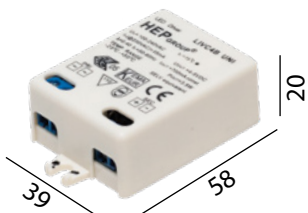

Schutzart	IP 20
Primärseitig	100-240V AC 50/60Hz
Umgebungstemp.	-20 – 50°C
Messpunkt tc	75°C
Dimmbar	—
Abmessungen	58 × 39 × 20mm

73007	700mA	3.5W
--------------	--------------	-------------

700mA / 12V DC CC/CV LED Konverter

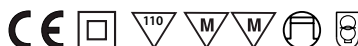

Schutzart	IP 20
Primärseitig	100-240V AC 50/60Hz
Umgebungstemp.	-20 – 50°C
Messpunkt tc	85°C
Dimmbar	—
Abmessungen	58 × 35 × 20mm

Für Betrieb von Konstantstrom **oder** Konstanspannung LED

73005-06	700mA / 12V DC	6W
-----------------	-----------------------	-----------

350/500mA LED Konverter



Schutzart	IP 20
Primärseitig	100-240V AC 50/60Hz
Umgebungstemp.	-25 – 45/50°C
Messpunkt tc	75°C
Dimmbar	—
Abmessungen	60 × 35 × 22mm

730004	350mA	1-8W
730009	500mA	1-6W

700mA LED Konverter

Ersatz für:
5520
5521

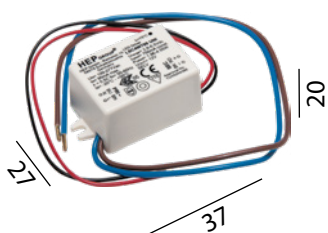

Schutzart	IP 20
Primärseitig	100-277V AC 50/60Hz
Umgebungstemp.	-20 – 50°C
Messpunkt tc	75°C
Dimmbar	—
Abmessungen	37 × 27 × 20mm

730079	700mA	1.9-4.5W
--------	-------	----------

Alle Preise excl. MwSt. und VRG.

350mA LED Konverter



Schutzart	IP 20
Primärseitig	100-240V AC 50/60Hz
Umgebungstemp.	-20 – 50°C
Messpunkt tc	70°C
Dimmbar	—
Abmessungen	85 × 40 × 22mm

73004	350mA	1-8W mit Stecker
-------	-------	------------------

Zubehör		
72002		Verteiler 6-fach

350 / 500 / 700mA LED Konverter



Schutzart	IP 20
Primärseitig	110-240V AC 50/60Hz
Umgebungstemp.	-25 – 45/50°C
Messpunkt tc	70/80°C
Dimmbar	—
Abmessungen	122 × 38 × 28mm

730023	350mA	1-17W
730046	500mA	2-20W
730034	700mA	2-17W

350mA LED Konverter

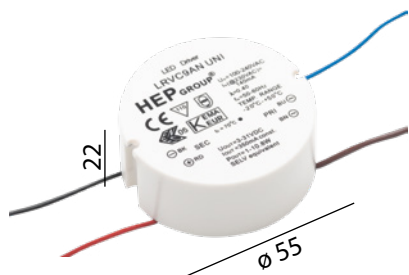

Schutzart	IP 20
Primärseitig	100-240V AC 50/60Hz
Umgebungstemp.	-20-50°C
Messpunkt tc	70°C
Dimmbar	—
Abmessungen	ø55 × 22mm

LRVC9AN UNI 350mA 1-10.8W

350mA LED Konverter



Schutzart	IP 20
Primärseitig	100-265V AC 50/60Hz
Umgebungstemp.	-20 - 50°C
Messpunkt tc	90°C
Dimmbar	—
Abmessungen	100 × 40 × 28mm

LT 901010350 350mA 10W mit Schraubklemme

Solange der Vorrat reicht

350 / 700mA LED Konverter

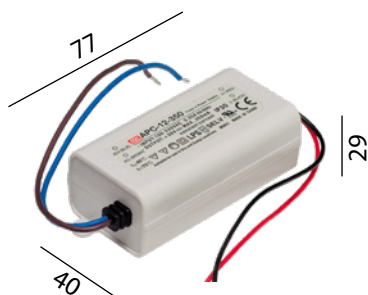

Schutzart	IP 30
Primärseitig	100-240V AC 50/60Hz
Umgebungstemp.	-30 - 70°C
Messpunkt tc	75/80°C
Dimmbar	—
Abmessungen	77 × 40 × 29mm

730010	350mA	3-12W
730011	350mA	4-16W
730012	700mA	6-12W
730013	700mA	6-16W

Solange der Vorrat reicht

350 / 500 / 700mA LED Konverter

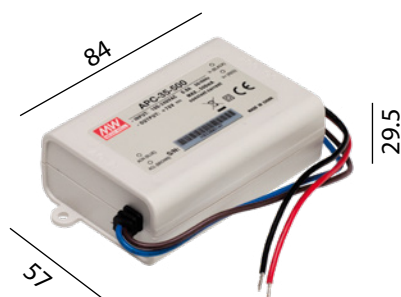

Schutzart	IP 30
Primärseitig	100-240V AC 50/60Hz
Umgebungstemp.	-30 - 70°C
Dimmbar	—
Abmessungen	84 × 57 × 29.5mm

730005	350mA	10-35W
730006	500mA	12-35W
730007	700mA	10-35W

Solange der Vorrat reicht

350/700mA LED Konverter IP67

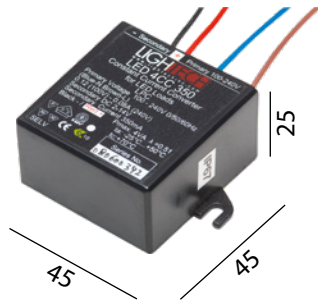

Schutzart	IP 67
Primärseitig	120-240V AC 50/60Hz
Umgebungstemp.	-25 – 50°C
Messpunkt tc	70/75/90°
Dimmbar	—
Abmessungen	45 × 45 × 25mm

LT 901004350	350mA	4W
LT 901006350	350mA	6W
LED 6CC 500 EP	500mA	6W
LT 901006700	700mA	6W

Solange der Vorrat reicht

350mA LED Konverter IP67



Schutzart	IP 67
Primärseitig	100-265V AC 50/60Hz
Umgebungstemp.	-25 – 50°C
Messpunkt tc	90°
Dimmbar	—
Abmessungen	133 × 40 × 31mm

LT 901018350P	350mA	18W
---------------	-------	-----

Solange der Vorrat reicht

Multi LED Konverter Smart 32



Schutzart	IP 20
Primärseitig	200-240V AC 50/60Hz
Umgebungstemp.	-25 – 50°C
Messpunkt tc	80°C
Dimmbar	—
Abmessungen	130 × 42 × 30mm

SEC	250mA	300mA	350mA	400mA	450mA	500mA	550mA	600mA
Pout	11W	13W	16W	18W	20W	22W	25W	27W
SEC	650mA	700mA	750mA	800mA	850mA	900mA	950mA	1000mA
Pout	29W	32W	32W	32W	32W	32W	32W	32W

730049

250...1000mA

11...32W

Potentiometer für 1-10V LED Konverter

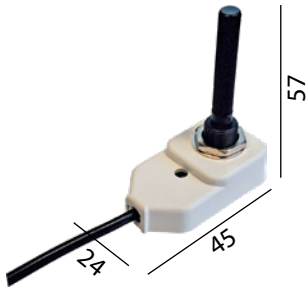

73195

Potentiometer für 1-10V Konverter

Schutzart IP20
Abmessungen 24 × 45 × 57mm
Mit M10 Gewinde und Mutter für Montage

350 / 500mA 1-10V / Push DIM LED Konverter MICRO JOLLY



730045

350mA

1-6W

730044

500mA

1-6W



Schutzart IP 20

Primärseitig 220-240V AC 50/60Hz

Umgebungstemp. -25 – 50°C

Messpunkt tc 70°C

Dimmbar 1-10V / Taster potentialfrei

Abmessungen 57 × 50 × 22mm



Multi 1-10V / Push DIM LED Konverter

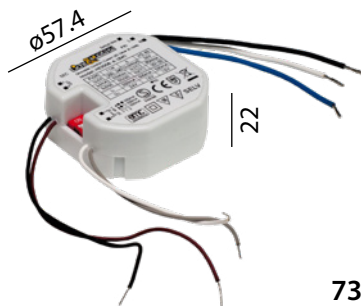

730065

350...550mA

8W



Schutzart IP 20

Primärseitig 220-240V AC 50/60Hz

Umgebungstemp. -20 – 50°C

Messpunkt tc 80°C

Dimmbar 1-10V / Push DIM

Abmessungen ø57.4 × 22mm



SEC	350mA	500mA	550mA
Pout	8W	8W	8W

Solange der Vorrat reicht

Multi 1-10V / Push DIM LED Konverter MINI JOLLY



730042

350...900mA

10...24V DC

9...20W



Schutzart IP 20

Primärseitig 110-240V AC 50/60Hz

Umgebungstemp. -25 – 50°C

Messpunkt tc 80°C

Dimmbar 1-10V / Push DIM

Abmessungen 111 × 52 × 22mm



SEC	350mA	500mA	550mA	700mA	850mA	900mA	10V DC	12V DC	24V DC
Pout	15W	20W	20W	20W	20W	20W	9W	10W	20W

Multi 1-10V / Push DIM LED Konverter JOLLY

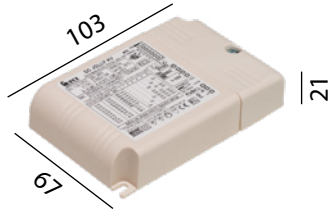

Schutzart	IP 20
Primärseitig	220-240V AC 50/60Hz
Umgebungstemp.	-25 – 50°C
Messpunkt tc	75°C
Dimmbar	1-10V / Push DIM
Abmessungen	103 × 67 × 21mm

SEC	250mA	350mA	400mA	450mA	500mA	550mA	600mA	12V DC	24V DC	28V DC
Pout	14W	19W	22W	25W	25W	25W	25W	8W	17W	20W

730043

350...700mA

10...24V DC

18...25W

Multi 1-10V / Push DIM LED Konverter JOLLY DIN



Schutzart	IP 20
Primärseitig	220-240V AC 50/60Hz
Umgebungstemp.	-25 – 50°C
Messpunkt tc	75°C
Dimmbar	1-10V / Push DIM
Abmessungen	90 × 70 × 36mm

SEC	200mA	250mA	300mA	350mA	400mA	450mA	500mA
Pout	10W	13W	16W	19W	21W	24W	27W
SEC	550mA	600mA	650mA	700mA	750mA	800mA	
Pout	29W	32W	32W	32W	32W	32W	

730068

200...800mA

10...32W

Multi 1-10 / Push DIM LED Konverter MAXI JOLLY SLIM HV (mit höherer Leistung)



Schutzart	IP 20
Primärseitig	220-240V AC 50/60Hz
Umgebungstemp.	-25 – 45°C
Messpunkt tc	75°C
Dimmbar	1-10V / Push DIM
Abmessungen	280 × 40 × 22mm

SEC	250mA	350mA	400mA	450mA	500mA	550mA	600mA	700mA	58V DC
Pout	30W	40W	47W	50W	55W	60W	60W	60W	40W

730067

250...700mA

58V DC

30...60W

Tasterkoppler für bis 25 Geräte

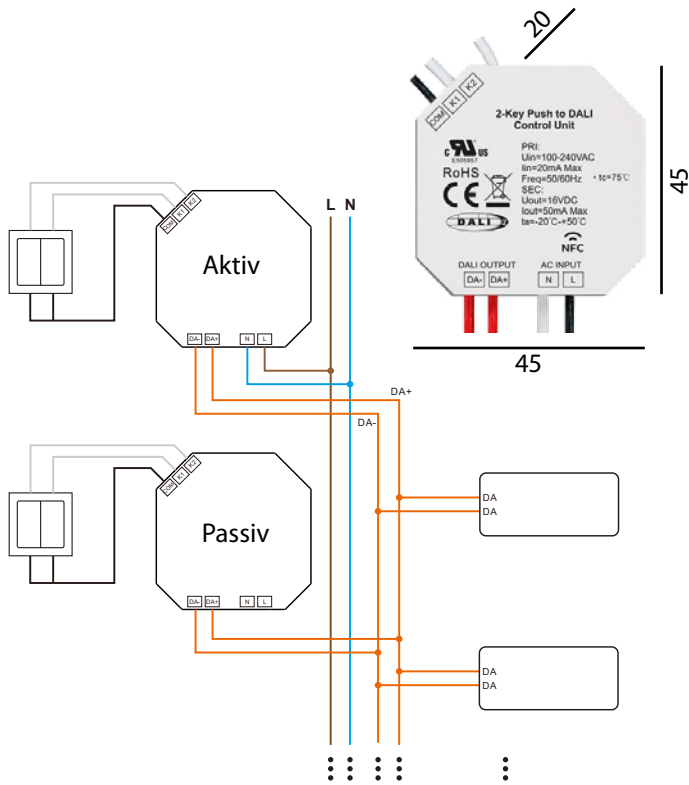

Schutzart	IP20
Stromversorgung	230 V
DALI Steuerstrom	50mA
Für DALI Protokoll	DT6 / DT8 Tc / DT8 xy / DT8 RGBWAF
Tastereingang	2 × Potentialfrei
Leitungslänge Taster	200m
Tasterfunktion	Programmierbar mit NFC App
Eingabeoptionen	Drücken / Halten / 2 × Drücken
Abmessungen	45 × 45 × 20mm

Anzahl von DALI Geräten	Broadcast	DALI Adressen	DALI Gruppen	Dim	CCT	RGBW
25	✓	2	2	✓	✓	✓

- Für 2 potentialfreie Taster oder Bewegungsmelder
- Zum Einbau in Unterputzdosens

NFC Configuration Software



für Android



für iOS

73180

Tasterkoppler für bis 25 DALI Geräte

Tasterkoppler für bis 32 Geräte mit Smartphone Steuerung

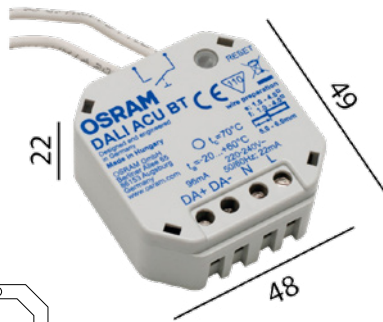

Schutzart	IP20
Stromversorgung	230 V
DALI Steuerstrom	96mA
DALI Protokoll	DT6 / DT8 Tc
Tastereingang	1 × Potentialfrei
Leitungslänge Taster	max. 50m
Tasterfunktion	Fest voreingestellt
Eingabeoptionen	Drücken / Halten
Abmessungen	48 × 49 × 22mm

Anzahl von DALI Geräten	Broadcast	DALI Adressen	DALI Gruppen	Dim	CCT	RGBW
32 + 4 Sensoren	✓	—	4	✓	✓	✓

- Steuern der Beleuchtung via Smartphone oder Taster
- Plug and Play: Basisfunktionen ohne App verfügbar
- ! **Nicht kompatibel mit CASAMBI !**

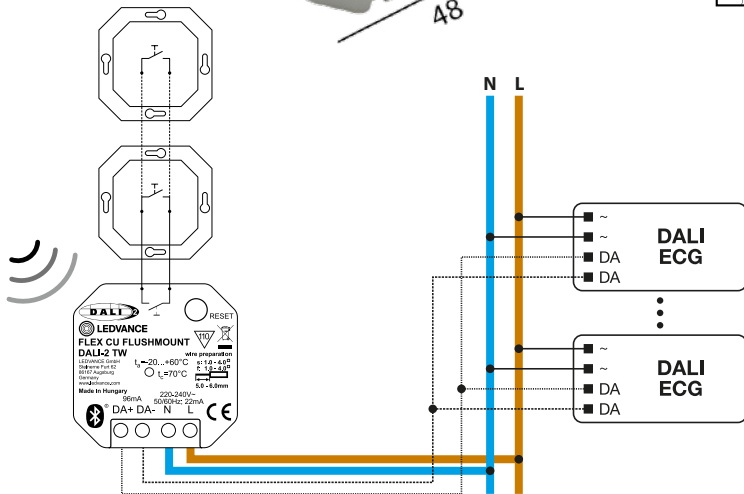

Os 841901

Steuermodul für bis 32 DALI Geräte

Phasenabschnitt Dimmer **3-25W** mit Steuerung

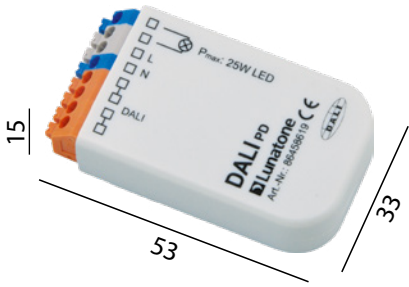

Schutzart	IP20
Stromversorgung	230 V
Abmessungen	53 x 33 x 15mm



25W Phasenabschnitt Dimmer, der über ein DALI Signal gesteuert werden kann.

Zur steuerung von E14 / E27 / G9 / GU10 retrofit Leuchtmitteln.

73160

3-25W Phasenabschnitt Dimmer mit **DALI** Steuerung

Phasenabschnitt Dimmer **10-300W** mit Steuerung



Schutzart	IP20
Stromversorgung	230 V
Abmessungen	130 x 30 x 22mm

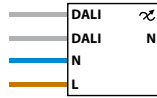

300W Phasenabschnitt Dimmer, der über ein DALI Signal gesteuert werden kann.

Zur steuerung von E14 / E27 / G9 / GU10 retrofit Leuchtmitteln.

73162

10-300W Phasenabschnitt Dimmer mit **DALI** Steuerung

Phasenabschnitt Dimmer **200W** mit Steuerung

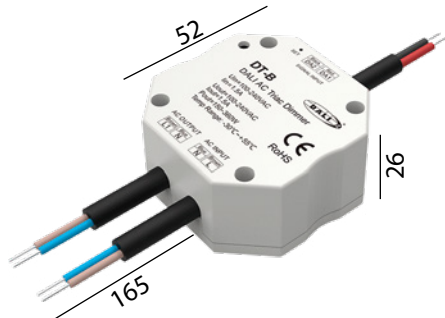

Schutzart	IP20
Stromversorgung	230 V
Abmessungen	52 x 52 x 26mm



200W Phasenabschnitt Dimmer, der über ein DALI Signal gesteuert werden kann.

Zur steuerung von E14 / E27 / G9 / GU10 retrofit Leuchtmitteln.

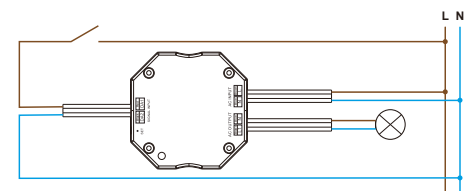
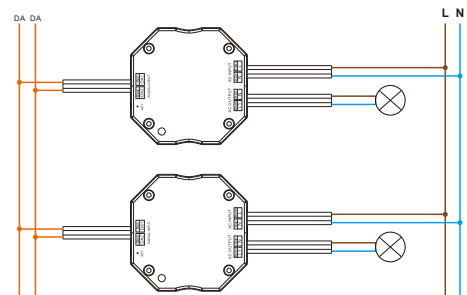

73163-05

200W Phasenabschnitt Dimmer mit **DALI** Steuerung

RC Glied - Filter gegen das Nachglimmen von LED

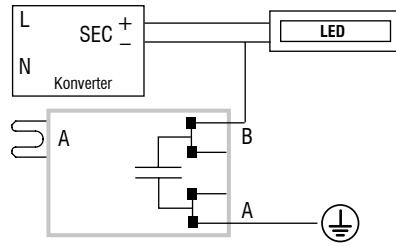

Schutzart IP20
 Abmessungen 25 × 36 × 11mm
 Kann auch an das metallischen Gehäuse der Leuchte angeschlossen werden

73196

RC Glied - Filter gegen das Nachglimmen der LED

LED Unterputz-Dimmer 5-150W

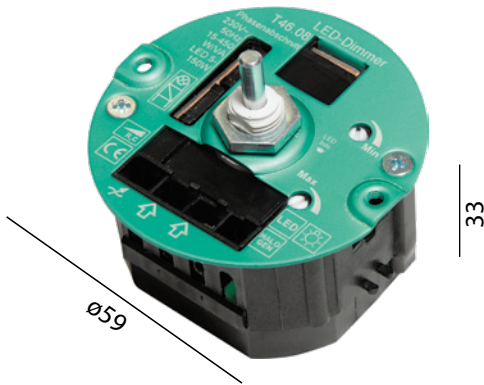

Schutzart IP 20
 Primärseitig 230V AC 50Hz
 Abmessungen ø59 × 33mm

Drehdimmer mit Druck-Wechsel-Schalter.
 Min- und Maximalhelligkeit einstellbar.

80360

LED Unterputz-Dimmer 5-150W (15-450W bei nicht LED)

LED Schnurdimmer 3-55W

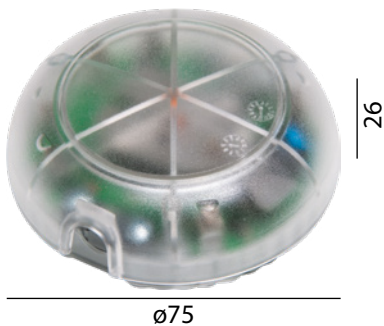

Schutzart IP 20
 Primärseitig 230V AC 50Hz
 Abmessungen ø75 × 26mm

Ein / Aus / Dimmen über Druck
 (Hand- und Fussbedienung möglich)

Min- und Maximalhelligkeit einstellbar.



- 80362-WS weiss LED Schnurdimmer 3-55W (5-150W bei nicht LED)
- 80362-SZ schwarz LED Schnurdimmer 3-55W (5-150W bei nicht LED)
- 80362-TR transparent LED Schnurdimmer 3-55W (5-150W bei nicht LED)

LED Schnurdimmer 3-35W

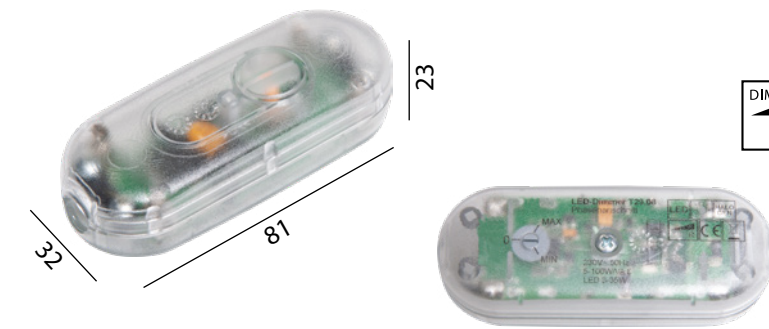

Schutzart	IP 20
Primärseitig	230V AC 50Hz
Abmessungen	81 × 32 × 23mm

Ein / Aus / Dimmen durch Tastbetätigung

Min- und Maximalhelligkeit einstellbar.



80365-WS	<input type="checkbox"/> weiss	LED Schnurdimmer 3-35W (5-100W bei nicht LED)
80365-SZ	<input type="checkbox"/> schwarz	LED Schnurdimmer 3-35W (5-100W bei nicht LED)
80365-TR	<input type="checkbox"/> transparent	LED Schnurdimmer 3-55W (5-100W bei nicht LED)

LED Schnurdimmer 3-35W

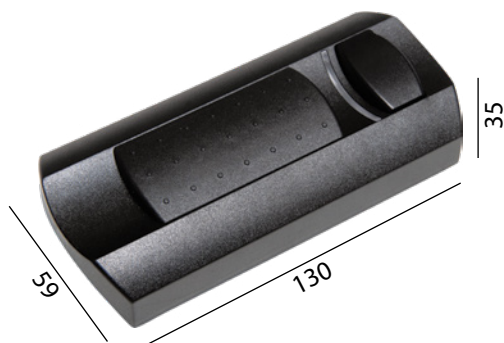

Schutzart	IP 20
Primärseitig	230V AC 50Hz
Abmessungen	130 × 59 × 35mm

Ein / Aus über separaten Schalter
Dimmen über Schieberegler

Minimalhelligkeit einstellbar.



80370-SZ	<input type="checkbox"/> schwarz	LED Schnurdimmer 3-35W (7-110W bei nicht LED)
80370-TR	<input type="checkbox"/> transparent	LED Schnurdimmer 3-35W (7-110W bei nicht LED)

LED Schnurdimmer 3-150W

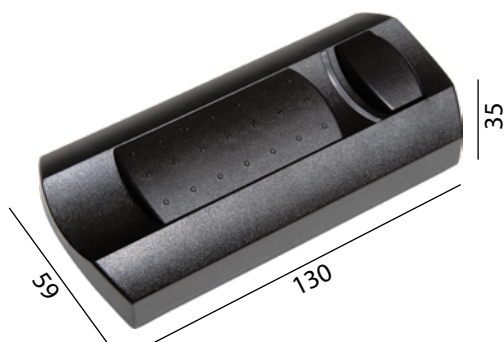

Schutzart	IP 20
Primärseitig	230V AC 50Hz
Abmessungen	130 × 59 × 35mm

Ein / Aus über separaten Schalter
Dimmen über Schieberegler

Minimalhelligkeit einstellbar.



80373-SZ	<input type="checkbox"/> schwarz	LED Schnurdimmer 3-150W (20-500W bei nicht LED)
80373-TR	<input type="checkbox"/> transparent	LED Schnurdimmer 3-150W (20-500W bei nicht LED)

HaloX-100

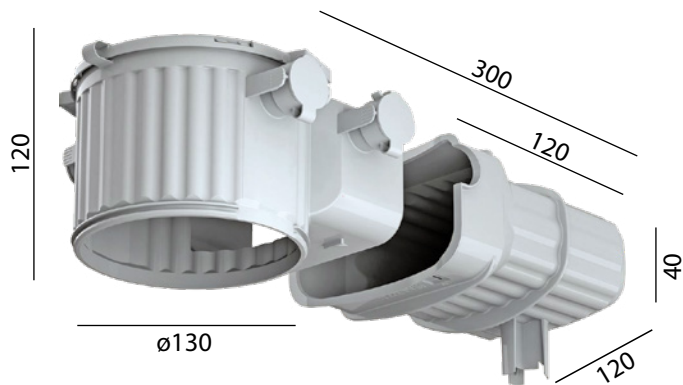

Beton-Einbaugehäuse für HV/NV-Einbauleuchten

HaloX-100 Gehäuse für Betondecken und -wände, Gehäuse und Tunnel aus Polyethylen, formbeständig bis 100°C, feuerbeständig bis 650°C, halogenfrei, schwenkbare Trennwand zwischen Gehäuse und Tunnel reduziert die Temperaturbelastung im Transformbereich.

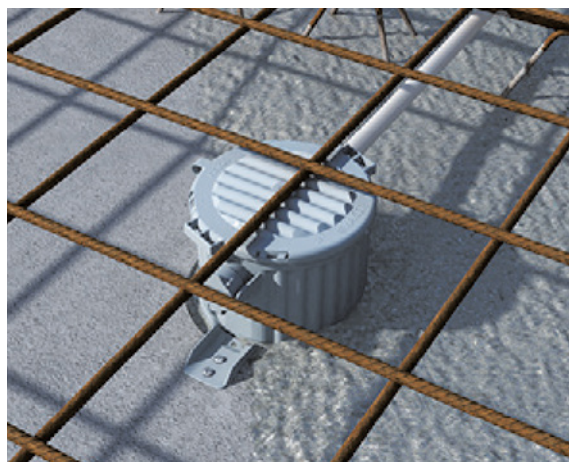

Beton-Einbaugehäuse

1281-00	HaloX-100 Betongehäuse ohne Frontdeckel / ohne Tunnel
1281-30	HaloX-100 Betongehäuse ohne Frontdeckel / mit Tunnel

Frontdeckel		Ausschnitt	Leuchtenblende min.
1281-01	rund	ø68mm	ø75mm
1281-02	rund	ø75mm	ø87mm
1281-03	rund	ø80mm	ø92mm
1281-04	rund	ø85mm	ø97mm
1281-05	rund	ø90mm	ø102mm
1281-06	rund	ø95mm	ø107mm
1281-07	rund	ø100mm	ø112mm
1281-08	quadratisch	68×68mm	75×75mm
1281-09	quadratisch	75×75mm	82×82mm
1281-10	universal	ø40-100mm	—
1281-11	Mineralfaserplatte	ø0-100mm	—

Verlängerungsringe

1281-21	Erhöhung der Einbautiefe um jeweils 10mm
1281-25	Erhöhung der Einbautiefe um jeweils 25mm
1281-50	Erhöhung der Einbautiefe um jeweils 50mm

HaloX-180

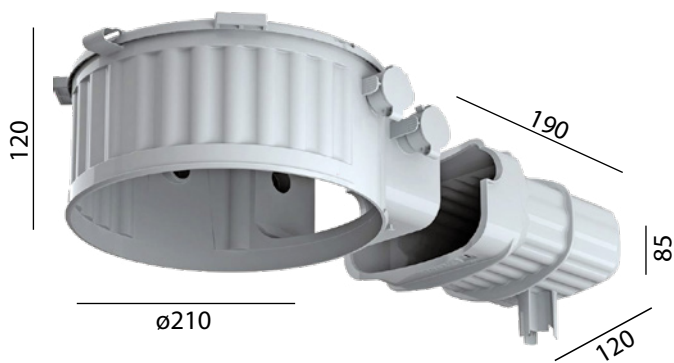

Beton-Einbaugehäuse für HV/NV-Einbauleuchten

HaloX-180 Gehäuse für Betondecken und -wände, Gehäuse und Tunnel aus Polyethylen, formbeständig bis 100°C, feuerbeständig bis 650°C, halogenfrei, schwenkbare Trennwand zwischen Gehäuse und Tunnel reduziert die Temperaturbelastung im Transformbereich.

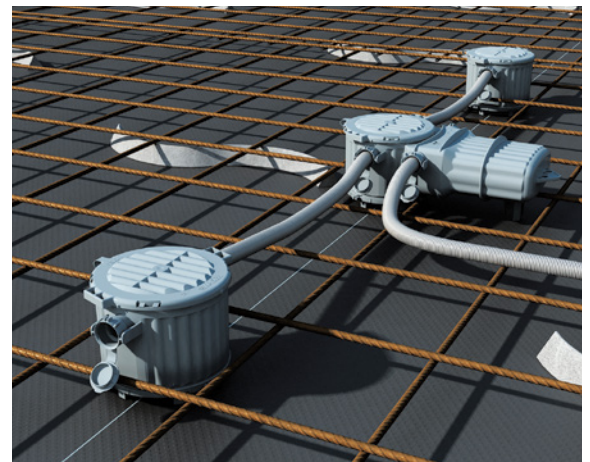

Beton-Einbaugehäuse

1282-00	HaloX-180 ohne Frontdeckel / ohne Tunnel
1282-30	HaloX-180 ohne Frontdeckel / mit Tunnel (kurz)
1282-40	HaloX-180 ohne Frontdeckel / mit Tunnel (Lang)

Frontdeckel		Ausschnitt	Leuchtenblende min.
1282-01	rund	Ø100mm	Ø107mm
1282-02	rund	Ø110mm	Ø117mm
1282-03	rund	Ø125mm	Ø132mm
1282-04	rund	Ø145mm	Ø152mm
1282-05	rund	Ø160mm	Ø167mm
1282-06	rund	Ø180mm	Ø187mm
1282-10	universal	Ø40-180mm	—
1282-11	Mineralfaserplatte	Ø0-180mm	—



Verlängerungsringe

1282-25	Erhöhung der Einbautiefe um jeweils 25mm
1282-50	Erhöhung der Einbautiefe um jeweils 50mm

EB-Gehäuse Lumina

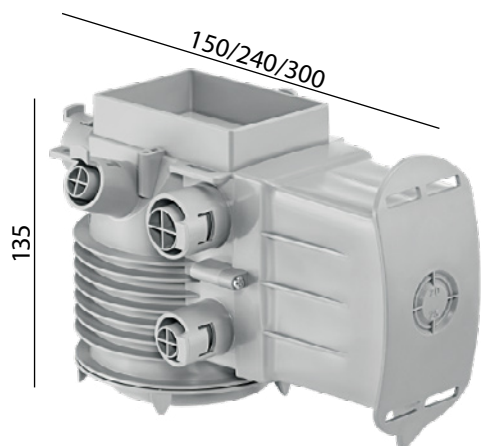

Innendurchmesser:	85mm
Rohreinführung:	M20 / M25
Farbe:	grau
Anwendung:	Sichtbeton

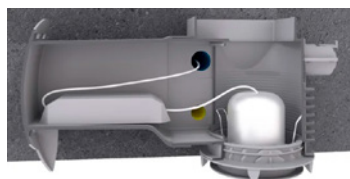

- Anpassungsfähig: Tunnel horizontal oder vertikal / 2 Grössen
- Tunnel mit sicherer Schraubverbindungen
- Armierungshalterungen
- Kompaktes Gehäuse für freie/dichte Anordnung



Beton-Einbaugehäuse	
920 991 009	Lumina EB-Gehäuse ohne Tunnel
920 992 009	Lumina EB-Gehäuse mit Tunnel 90mm
920 993 009	Lumina EB-Gehäuse mit Tunnel 150mm

Frontdeckel	Ausschnitt
920 994 689 rund	ø68mm
920 994 809 rund	ø80mm

Firestop-Boxen

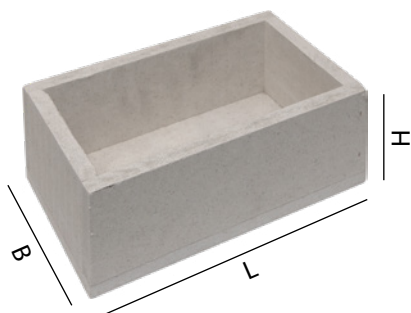

Nur bei Firestop 1 & 2 können elektronische Trafos versetzt in die Box angewendet werden. Leuchtmittel nur Alurefektor 12V oder 230V, wenn möglich nur mit 35W bestücken.

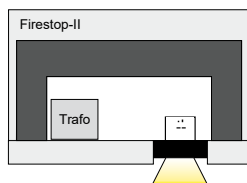

Bezeichnung	Durchmesser	Sichtbeton	VE
3.220-160-90 Firestop-Box 1 (15mm)	L 220 / B 160 / H 90	nein	1
3.220-220-90 Firestop-Box 2 (15mm)	L 320 / B 220 / H 90	nein	1
3.160-160-110 Firestop-Box 3 (15mm)	L 160 / B 160 / H 110	nein	1
3.220-160-110 Firestop-Box 4 (15mm)	L 260 / B 160 / H 110	nein	1
Spezialmass Firestop-Box 5	Nach Mass	bedingt	1

Kabelverbinder



IP68 2polig



IP68 3polig

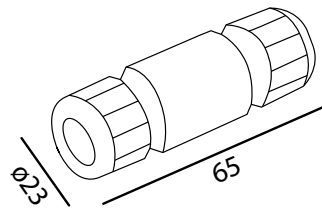

IP68 4polig

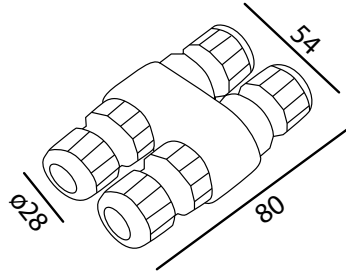

00005-10	Kabelverbinder Schraubanschluss IP68 2polig
00005-11	Kabelverbinder Schraubanschluss IP68 3polig
00005-12	Kabelverbinder Schraubanschluss IP68 4polig
00005-13	Blende

Kabelverbindungen IP68

Kabelverbindungen absolut wasserdicht. Geeignet für einfaches Verbinden im Aussen-/Nassbereich.

Hülle aus Nitrilkautschuk und Silikondichtung. Die Klemme ist geeignet für Litze und Draht.



Kabelkupplung



Schraubanschluss 2polig



Schraubanschluss 3polig

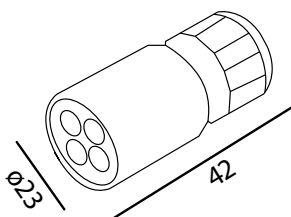

Kabelkupplung IP68

Neue Kabelverschraubung mit folgenden Vorteilen:

+10 mm lang: mehr Innenraum für die Verdrahtung von Kabeln.

Maximaler installierter Kabeldurchmesser 14,0 mm

Absolut Wasserdicht.

00005-01	Rundstecker mit Kupplung IP68 2polig
00005-02	Rundstecker mit Kupplung IP68 3polig

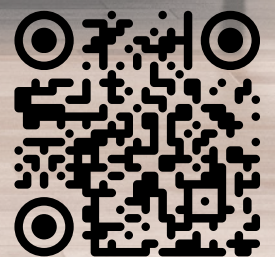

www.lichtconcept.ch